

PowerMaster-360R

User's Guide

Table of Contents

1. Introduction	3	B.3 Recalling the zone bypass scheme	20
Preface	3	B.4 Programming user codes	22
Overview	3	B.5 Programming the duress code	24
System features	3	B.6 Add and delete proximity tags	24
PowerMaster-360R panel indicators and keys	4	B.7 Add or delete keyfob transmitters.....	26
Keypad display	6	B.8 Setting the time and format	28
Screen saver mode.....	6	B.9 Setting the date & format	29
Proximity tags	6	B.10 Enabling and disabling auto-arming	30
Users and codes.....	6	B.11 Setting the auto-arming time	30
2. Operating the PowerMaster-360R system	7	B.12 Programming Email, MMS and SMS reporting.....	31
Preparing to arm	7	B.13 Enabling and disabling the squawk option	37
Arming 'AWAY' or 'HOME'	7	B.14 Programming the Scheduler.....	37
Disarming and preventing the alarm	7	B.15 Volume Control	39
Disarming under duress	8	B.16 Serial number.....	42
Partition selection process	8	B.17 PowerLink parameters	43
Switching from 'HOME' to 'AWAY'	8	5. Event reporting and control by SMS	44
Switching from 'AWAY' to 'HOME'	8	Event notifications by SMS.....	44
Arming AWAY or HOME 'Instant'	9	Remote control by SMS.....	45
Forced arming AWAY or HOME	9	6. Special applications and functions	46
Arming in latchkey mode.....	10	Looking after people at home	46
Initiating panic alarm	10	Acknowledging "low battery" condition in Keyfobs	46
Initiating fire alarm or emergency alarm	11	7. Testing the system	47
Chime ON or Chime OFF	11	Periodic test	47
4. Electrical Appliance Control	12	Periodic test per partition.....	49
Control Options and Pushbuttons	12	8. Maintenance	51
Automatic ON/OFF Control	12	Replacing the backup battery	51
3. Reviewing events and alarm memory	13	Replacing wireless devices batteries	51
Alarm and tamper memory history	13	Accessing 24-hour zones	51
Clearing the memory history	13	Cleaning the control panel	51
Problems with enrolled devices.....	13	Event log	51
General indications	14	Exiting the event log	52
Correcting trouble conditions	15	Appendix A. Controlling device functions	53
4. Menus and functions	16	A1. KP-160 PG2.....	53
A.1 Entering the user settings menu & selecting an option	16	A2. KP-140/141 PG2.....	54
A.2 Returning to the previous step or exiting the USER SETTINGS menu	18	A3. KF-234 PG2.....	55
A.3 Keys used for navigation and settings ..	18	Appendix B. Partitioning	56
B.1 Setting the zone bypass option.....	18	B1. Selecting a partition.....	56
B.2 Reviewing the zone bypass scheme.....	20	B2. Arming and disarming the system	56

B3. The Show Function.....	56	E2. Wireless	63
B4. Siren.....	57	E3. Electrical	64
B5. Partition status display.....	57	E4. Communication	64
B6. Common areas.....	57	E5. Physical Properties	64
Appendix C. Glossary	59	E6. Peripherals and Accessory Devices	64
Appendix D. Home fire escape planning	62	Appendix F. Compliance with standards	66
Appendix E. Specifications	63		
E1. Functional	63		

1. Introduction

Preface

The PowerMaster-360R is an advanced wireless alarm control system produced by Visonic Ltd.

Note: Ensure that you have both the name and telephone number of the monitoring station that your system reports to. When calling the monitoring station, you must have access to your "ACCOUNT NUMBER" to identify your alarm system. The account number is provided to you by the installation engineer; ensure that you store the number in a secure location.

Overview

The PowerMaster-360R is a wireless alarm system for detecting and alerting in case of burglary, fire and a variety of other security and safety hazards. In addition, it can be used to monitor the activity of disabled or elderly people at home. System status information is presented visually.

The system includes an optional partition feature for a description of this feature, refer to Appendix B.

The PowerMaster-360R is governed by a control panel that is designed to collect data from various sensors that are strategically located within and along the perimeter of the protected site.

The alarm system can be armed or disarmed by a variety of keyfobs and keypads using special codes.

In the **disarmed state**, the system provides you with visual status information, and initiates an alarm if smoke is detected or upon disturbance in a 24-hour zone (a zone which is active 24-hours a day).

In the **armed state**, the system initiates an alarm upon detection of disturbance in any one of the armed zones.

Proximity tags enable authorized people to enter restricted areas.

The system identifies a wide range of events - alarms, attempts to tamper with sensors and several types of trouble. Events are automatically reported by Broadband or GPRS communication to monitoring stations (in IP form) and to private telephones (SMS messages) or emails (through the server). The person receiving such a message is expected to investigate the event and act accordingly.

IMPORTANT! All you need to know to secure your premises can be found in Chapter 2 of this manual.

If you are not familiar with some of the terms used here, refer to Appendix C at the end of this guide.

Note: This system must be checked by a qualified technician at least once a year.

System features

Your PowerMaster-360R offers a large number of unique features:

- **Master / User Settings:** Two user levels allow different access types (see Chapter 4. Menus and functions, section B.4 Programming User Codes).
- **64 detector zones:** Each detector zone is identified by zone number and name (location).
- **Multiple arming modes:** AWAY, HOME, AWAY- INSTANT, HOME-INSTANT, LATCHKEY and BYPASS.
- **Keypad:** Status information and prompts are displayed on the touch or virtual keypad.
- **Real-time clock:** The present time is visible on the Keypad display. This feature is also used for the log file by providing the date and time of each event.
- **Various reporting destinations:** Events can be reported automatically to monitoring stations, private telephones and mobile phones. Events can be reported by SMS if GSM is installed. See Chapter 4. Menus and functions for details.
- **Selective reporting:** Your installer can determine what type of events will be reported to which destination.
- **Latchkey mode:** An automatic "Latchkey" message is sent to chosen telephones if the system is disarmed by a "latchkey" user for example a junior family member. See Chapter 2 for details.
- **Access from remote telephones:** You may access the PowerMaster-360R from a remote telephone and Arm/Disarm it or receive system status information. See Chapter 5 for details.
- **Numerical keys serve as function keys:** When the system is disarmed, the numerical keys are used also to control various system functions. A simple icon on each key identifies the task of that key.
- **Data retrieval:** You can obtain status information, trouble information and review memorized alarm events visually (see Chapter 3).
- **Event log:** System events are memorized in an event log that stores the most recent events, each tagged with the time and date of the event. You can access this log and review the past events if required. See Chapter 8. Maintenance for details.
- **Looking after elderly and infirm individuals:** The system can be programmed to monitor people activity

Introduction

within the protected area and send out an alert message if no movement is detected for a predefined period of time. See Chapter 4. Menus and functions for details.

- **Distress calls:** Keyfobs may be used to activate this function by the simultaneous pressing of two buttons.
- **Disarming under duress:** If a user is forcibly compelled to disarm the system, they can do so using a special code ("Duress Code") that disarms the system as usual, but also sends a silent alarm to the monitoring station. See Chapter 2. Operating the PowerMaster-360R for details.
- **System supervision:** All wireless peripherals within the protected site send periodic keep alive supervision messages. If such a message is overdue, the Keypad displays a 'missing' TRBL message. Your installer can disable this feature if not required.
- **Battery supervision:** The PowerMaster-360R continuously monitors the battery condition of the sensors and devices in the system and the Keypad displays a 'Low Battery' message whenever a battery needs to be replaced within a maximum of 30 days. Wireless sirens can still provide 2 siren alarms before the siren becomes totally inactive.

Note: When the 'Low Battery' message is received, the battery should be replaced within 7 days. The PowerMaster-360R battery is rechargeable, see Chapter 8 Maintenance for troubleshooting information.

PowerMaster-360R panel indicators and keys

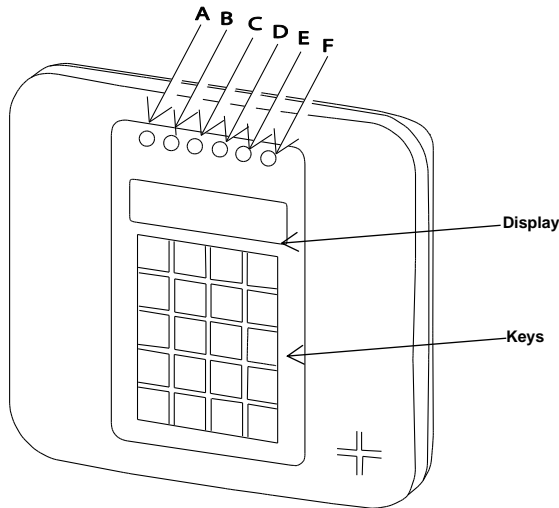











Figure 1. PowerMaster-360R







Led indicators

Label	Function
(A)	Power  (Green) indicates that your system is connected to the power outlet.
(B)	Arming Status  (Flashing Red / static Red) indicates HOME or AWAY.
(C)	Trouble condition (TRBL)  (Orange) lights when the system detects an abnormal condition caused by a fault, see Chapter 3 for details.
(D)	Service Server  (Blue) lights when the system is connected to the security server.
(E)	Smart Home Service  (Blue) lights when the system is connected to the smart home server.
(F)	WiFi  (Green) indicates if the WiFi module is enabled or disabled. The light blinks fast when activating or deactivating a WiFi access point and blinks slowly when the WiFi access point is active.







Control keys

Key	Definition	Navigation / Setting Function
	Next	Press to move forward to the next menu option.
	Back	Press to scroll back to the previous menu option.
	OK	Press to select a menu option or to confirm a setting or action.

Arming keys

Key	Definition	Navigation / Setting Function
	Arm away	Press to arm building when empty.
	Arm home	Press to arm building when occupied.
	OK	Press to select a menu option or to confirm a setting or action.
	Cancel delay	Press to cancel the entry delay when the system is armed to home or away.
	Disarm	Press to disarm the system and silence alarms.
	Partition	Press to select a partition.

Other keys

Key	Definition	Navigation / Setting Function
	Chime	Press to turn on or off chime.
	Event log	Press to review the event log.
	Emergency	Press and hold for 2 seconds to generate an emergency alarm.
	Fire	Press and hold for 2 seconds to generate a fire alarm.
	Panic alarm	Press both simultaneously to generate a panic alarm.
	Volume up	Press to increase volume.
	Volume down	Press to decrease volume.

Audible indicators

The panel provides the following audible indications:

Audible indicator	Definition
One single beep	Indicates that a key is pressed on the keypad.
Double beep	Indicates normal operating mode is restored after a timeout.
Three short beeps	Indicates a trouble condition (TRBL) is detected with an enrolled device.
Success tune	Indicates a successful operation.
Failure tune	Indicates that an input or action is incorrect.

Introduction

Keypad display

The keypad display shows the system status and events, time and date, programming instructions and also an event log file which is accompanied by the date and time of each event. The normal display alternates with the time and the system status, for example:

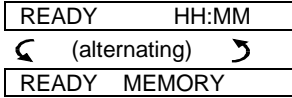

Screen saver mode

For security reasons, it is sometimes required to hide the status indication (Keypad and LED display) from a potential intruder. If the Screen Saver option is enabled by the installer, then if no key is pressed for more than 30 seconds, the Keypad display shows “PowerMaster-360R” and the LEDs stops indicating any status. Pressing any key resumes the normal status display. Pressing the Fire or Emergency keys will also initiate the Fire or Emergency alarm.

If configured by the installer for additional security, the system will ask you to enter your user code as well before resuming the normal display.

When partition is enabled, the installer can configure the system so that if no key is pressed during more than 30 seconds the date and time will appear on the Keypad display.

Proximity tags

The system responds to valid proximity tags enrolled in the system through remote devices with proximity tags readers such as the KP-141 PG2 or KP-160 PG2. The proximity tag enables you to perform a variety of functions without entering a user code, for example arming, disarming, access to event logs, etc. Whenever the user code is required, you can simply present a valid proximity tag and perform the required operation without the need to key-in the user code.

Users and codes

As a master User (User No.1) you require a 4-digit security code to control the system. Code 0000 is not allowed. You can also authorize 47 other people to use the system by providing them with their own security codes. Security codes are used mainly to arm and disarm the system or to access information that is restricted to authorized users only. See Chapter 4, B.4 Programming User Codes for details.

In addition, you can obtain up to 32 multi-function portable keyfob transmitters that you can use to easily arm, disarm and control the system without accessing the panel. Keyfobs work both inside and from outside the premises. See Chapter 2 and Chapter 4, section B.7 Add or delete keyfob transmitters for details.

The Duress Code enables you to disarm the system using a special code that sends a silent alarm to the monitoring station. See chapter 2 for details.

2. Operating the PowerMaster-360R system

For more information regarding terms used in this chapter, refer to Appendix C. G.

Basic arming and disarming

Following are a set of procedures for performing basic arming and disarming of the alarm system.

Preparing to arm

Before arming, make sure that READY is displayed.

READY HH:MM

This indicates that all zones are secured and you may arm the system as required.

If at least one zone is open (disturbed) the display will show NOT READY.

NOT READY HH:MM

This indicates that the system is not ready for arming and in most cases that one or more zones are not secured. However, it can also mean that an unresolved condition exists such as certain trouble conditions, jamming etc., depending on system configuration.

To review the open zones click **! OK**. The details and location of the first open zone detector, usually an open door or window sensor is displayed. To fix the open zone, locate the sensor and secure it that is close the door or window. See "device locator" below for details on how to find the sensor. Each click of **! OK** displays another open zone or trouble indication. It is highly recommended to fix the open zone or zones, in order to restore the system to the state of "ready to arm". If you do not know how to do this, consult your installer.

Note: To quit at any stage and to revert to the "READY" display, click **←**.

Device Locator: The PowerMaster-360R system has a powerful device locator that helps you to identify open or troubled devices indicated on the screen display. While the screen displays an open or faulty device, the LED on the respective device flashes indicating "it's me". The "it's me" indication will appear on the device within max. 16 seconds and will last for as long as the screen displays the device.



Arming 'AWAY' or 'HOME'

If the system is **READY** and/or Forced Arming is enabled proceed as shown below. For more information on Forced Arming, see "Forced Arming AWAY or HOME" below.

If the system is **NOT READY** and Forced Arming is not permitted, review any open zone detectors to locate and secure them.

If you want to arm using partitions, see "Partition Selection Process" and then proceed as shown below.

If the user has changed the state of the system from a high security mode to a lower security mode i.e. from ARM to DISARM, or from ARM to HOME, he will be prompted to enter the user code thus bypassing the QUICK ARM option.

PRESS	RESULTING DISPLAY
 / 	ARMING AWAY/HOME
If Quick Arm is disabled	ENTER CODE  _ _ _ _
Vacate the premises (ARM AWAY) OR Move to interior zone (ARM HOME)	PLEASE EXIT NOW ↓ (Exit delay) ↓
	AWAY/HOME

 **ARM indicator** lights steadily during the armed state.

Disarming and preventing the alarm

After entering the protected premises when an entry delay zone is operational, the panel sounds the entry delay beeps. This sound alerts you to disarm the system before the end of the entry delay period.

Electrical appliance control

After disarming, different displays may appear indicating that the system is in a state of alarm **MEMORY**. The **MEMORY** message disappears only when the system is rearmed. To disarm the system, proceed as shown:

PRESS	RESULTING DISPLAY
	ENTER CODE _ _ _ _
[Enter Code] / [Present tag]	Code / Present tag
	READY HH:MM

ARM indicator extinguishes during the disarmed state. Disarming the system also stops the siren alarm, irrespective of whether the alarm was initiated during the armed or the disarmed state.

Disarming under duress

If you are forcibly compelled to disarm the system, enter the duress code. The default value is 2580 or alternative code set by the installer. Disarming take place normally but a silent alarm is transmitted to the monitoring station.

Partition selection process

Access to any required partition is achieved through the use of an individual code or proximity tag. It is not possible to access the INSTALLER MODE menu if one or more partitions are in the AWAY or HOME modes. Before attempting to perform any operation on any given partition, you must select the required partition using the individual code or proximity tag. Complete the following steps to select a partition:

PRESS	RESULTING DISPLAY
	SELECT PARTITION
Enter partition # (1 - 3)	PARTITION 1

Note: The "Failure Tune" is heard when selecting a partition to which no sensors or peripherals were enrolled.

Special arming & disarming options

In addition to basic arming, PowerMaster-360R provides you with several advanced arming and disarming options:

Switching from 'HOME' to 'AWAY'

You do not have to disarm the system - just press . The response is the same as in ARMING AWAY. Vacate the premises before the exit delay expires.



Switching from 'AWAY' to 'HOME'



You do not have to disarm the system - just press . Since this operation reduces the security level, PowerMaster-360R prompts you to key in your master user code or user code, to ensure that you are an authorized user.

PRESS	RESULTING DISPLAY
	ENTER CODE _ _ _ _
[Enter code] / [Present tag]	Code / Present tag
	ARMING HOME
Move to interior zone	↓ (Exit delay) ↓
	ARM HOME HH:MM

ARM indicator flashes during the armed state.

Arming AWAY or HOME 'Instant'

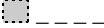
Pressing   during the exit delay arms the system immediately without a delay. Therefore, any detection in any zone triggers an immediate alarm. To arm AWAY-INSTANT, proceed as follows.

PRESS	RESULTING DISPLAY
	ENTER CODE 
Code	
	ARMING AWAY
 	ARMING INSTANT
	↶ (alternating) ↷
	PLEASE EXIT NOW
Vacate the premises	↓ (Exit delay) ↓
	AWAY



 **ARM indicator** lights during the armed state.

Forced arming AWAY or HOME

Forced arming allows you to arm the system even if the system is "NOT READY". Any open zones are bypassed for the duration of arming.

Note: When forced arming is carried out, the buzzer "protests" by emitting a continuous tone during the exit delay until the last 10 seconds of the delay. You can silence this signal by pressing the arming button again.

If forced arming is enabled and you wish to arm the system when NOT READY is displayed, complete the following steps:



PRESS	RESULTING DISPLAY
	ENTER CODE 
[Enter code] / [Present tag]	Code / Present tag
	ARMING AWAY
	PLEASE EXIT NOW
	↓ (Exit delay) ↓
(to mute the buzzer)	
Vacate the premises	AWAY

 **ARM indicator** lights during the armed state.

Remember: Forced arming compromises security!!

Electrical appliance control

Forced arming "HOME" is performed in a similar manner, as follows:

PRESS	RESULTING DISPLAY
	ENTER CODE  _ _ _ _ Code / Present tag
[Enter code] / [Present tag]	
	ARMING HOME
	PLEASE EXIT NOW
	↓ (Exit delay) ↓
(to mute the buzzer)	
Go to interior zone	HOME HH:MM





 **ARM indicator** flashes during the armed state.

Arming in latchkey mode

This mode, if enabled by the installer, is useful for example when a parent wants to be sure that their children have returned from school and have disarmed the system. A special "latchkey" message is sent out when the system is disarmed by a "latchkey user".

Latchkey users are holders of user codes or users of keyfob transmitters 5 through 8. The latchkey message is considered an alert and not an alarm. The message is sent to private telephone numbers that are programmed by the user to receive alert messages.

Latchkey arming is possible only when you arm "AWAY". To arm using the Latchkey mode, proceed as follows:

PRESS	RESULTING DISPLAY
	ARMING AWAY
	ARMING LATCHKEY
(Within 2 seconds)	 (alternating) 
	PLEASE EXIT NOW
Vacate the premises	↓ (Exit delay) ↓
	AWAY

Note: Latchkey must be enabled by your installer.

 **ARM indicator** lights during the armed state.

Initiating alarms

The following are various methods that can be used for initiating alarms.

Initiating panic alarm





You can generate a panic alarm manually in the disarmed and armed states, as follows:

PRESS	RESULTING DISPLAY
	PANIC ALARM
simultaneously	
	READY HH:MM

To stop the alarm, press the  button and then key in your valid user code.

Initiating fire alarm¹ or emergency alarm



You can generate a fire alarm or a silent emergency alarm in disarmed & armed states, as follows:

PRESS	RESULTING DISPLAY
 OR  for 2 seconds	FIRE ALARM
	EMERGENCY
	Then, if or when the system is in the disarmed state:
	READY HH:MM
	 (alternating) 
	READY MEMORY

To stop the alarm, press  and then key in a valid user code.

Chime ON or Chime OFF

To disable or enable the chime zones, click the   key and click again to disable, see Appendix C for details.

PRESS	RESULTING DISPLAY
	CHIME ON
	CHIME OFF
	↓
	READY HH:MM

 CHIME indicator lights steadily when “chime on” is selected.

¹ This function is disabled in ACPO compliant version

Reviewing events and alarm memory

4. Electrical Appliance Control

Control Options and Pushbuttons

The system allows manual or automatic remote control of a device connected to a PGM output.

The user defines the ON and OFF times via the scheduler (see Chapter 4 – B.14 Programming the Scheduler). The installer determines which zone sensors will switch the remote controlled appliances on and off. **However, the decision whether the remote controlled appliance will respond as programmed is up to you** (see the following table).

Key	Function
3	Manual activation of a light or other household electrical appliance that is connected to a PGM output.
6	Manual deactivation of a light or other household electrical appliance that is connected to a PGM output.
9	Selecting the active automatic control method: <ul style="list-style-type: none">■ Sensors: The appliance is controlled by sensors (assigned by the installer for this).■ Timer: The appliance is controlled by timer (ON and OFF times are defined by the installer).■ Both: The appliance is controlled by sensors as well as by a timer.

Examples of benefits gained by automatic remote control:

Timer Control: When you are away, the activation / deactivation of an electrical appliance can be timed.

Zone Control: upon disturbance of a perimeter zone, the electrical device is switched on.

Notes:

1. Automatic activation and deactivation of an electrical appliance also depends on the Scheduler setup (see Chapter 4 – B.14 Programming the Scheduler).
2. PGM not to be enabled in UL listed products.

Automatic ON/OFF Control

You can select two of four options as follows:

- By timer ON
- By timer OFF
- By sensor ON
- By sensor OFF

The currently active options are shown with a dark box (■) at the far right hand side. To view the 2 other options click the **9** button.

A presently inactive option is shown without a dark box at the far right. The dark box will appear if you click **i | OK** while the option is displayed. A “success tune” indicates the successful saving of a new option.

PRESS

9

If not satisfied - press **9**

If satisfied - press **i | OK**

i | OK

9

If not satisfied - Press **9**

If satisfied - **i | OK**

i | OK

9

RESULTING DISPLAY

BY TIMER ON ■

(If this is the default)

BY TIMER OFF

BY TIMER OFF ■

BY TIMER OFF ■

BY SENSOR ON ■

BY SENSOR OFF

BY SENSOR OFF ■

BY SENSOR OFF ■

READY HH:MM

3. Reviewing events and alarm memory

Alarm and tamper memory history

The PowerMaster-360R retains in its memory alarm and “tamper” events that occurred during the last arming period.

Note: Alarm events are memorized only after the “abort period” (see Appendix C). This means that if you disarm the system immediately - before the abort period expires - there is no memory indication

A. Indication of alarm and tamper condition

If the system is disarmed following an alarm event, a flashing **MEMORY** message is displayed, as follows:

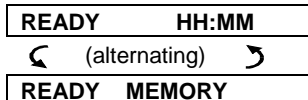

B. Displaying alarm and tamper information

To review memory content, click **INFO OK** button.

EXAMPLE: An alarm was triggered because the garage door - zone No. 12 – was opened **but then closed**. In addition, the bedroom motion detector - zone No. 7 - sent a “Tamper” message because its cover had been removed.

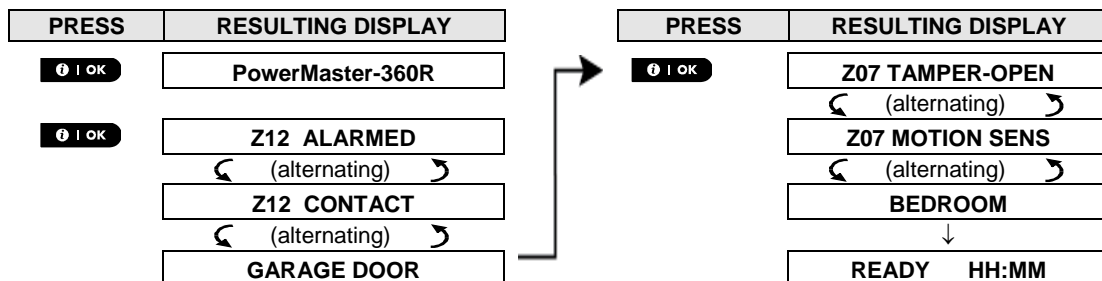

In response to additional clicking of the **INFO OK** button, the display shows details of other events retained in open tamper (if any), or reverts to its initial state (see A above).

If the system is NOT READY, the display first read the open zones and then alarm memory events.

Clearing the memory history

To clear the ‘Memory’ history you must first review the cause of alarm as described above. After you return to the ‘Ready’ screen press Away **ARM** and enter the code if requested, then press Disarm **DIS** followed by the code. The memory message is now cleared. Otherwise the memory indication and content are cleared when the system is next armed.

Problems with enrolled devices

A. Indication that a trouble condition (TRBL) is detected by the system

If the system detects a problem with any of the enrolled devices, the problem indicator on the Keypad illuminates, 3 beeps are sounded from the panel one per minute and a flashing **TRBL** message is displayed, as follows.

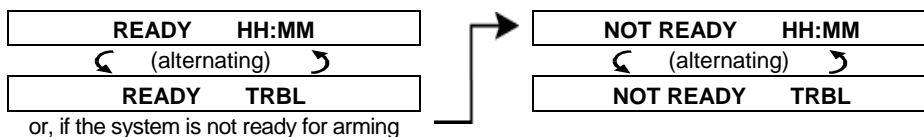

B. Displaying problems

All TRBL messages need to be reviewed and corrected as described below:

EXAMPLE: The kitchen device - zone No. 9 - has reported a low battery – the living room device zone No. 15 - has been inactive, and an attempt to communicate a message to your telephone has failed. However, these problems do not prevent the system from being “ready to arm”.

Reviewing events and alarm memory

To review the source of the current problems one by one, click the  I OK button repeatedly as shown below:

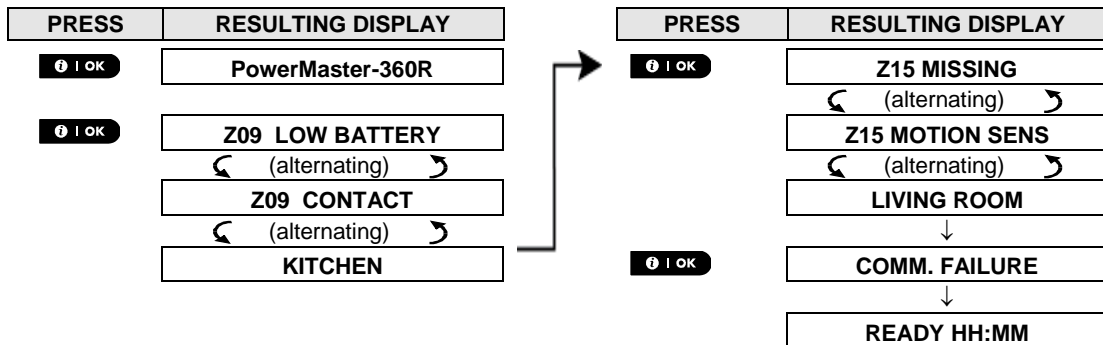

IMPORTANT! To silence the beeps, disarm the system again (even though it is already disarmed). **This will cancel the TRBL beeps for 4 hours.**

C. Reviewing memory and problems at the same time

If **alarms / tamper events** are retained in the alarm memory and at the same time a TRBL state exists, the display first shows the alarm memory followed by TRBL events, as described in sections A & B above.

General indications

A. Cellular connection indications





After all trouble messages have been reviewed and if a SIM card is installed in the panel, the PowerMaster displays the following indications:

- **GSM signal strength:** indicated as **CELL RSSI STRONG / CELL RSSI GOOD / CELL RSSI POOR.**
- **Network Type:** indicates the type of network the cellular modem is registered to. Represented by two characters, for example 2G or 3G.
- **Cellular Provider:** indicates the name of the cellular provider, which the cellular modem is registered to. Represented by 13 characters, for example Orange.

If a PIR camera is enrolled in the system, "GPRS initialize" is displayed following panel power-up to indicate that the modem is undergoing initialization. This message appears at the end of all TRBL messages and immediately following the GSM signal strength indication if a SIM card is installed.

B. Wi-Fi indications

After all trouble messages have been reviewed, the PowerMaster displays the following Wi-Fi signal strength indications:

- Excellent Wi-Fi signal strength is displayed as – **WiFi level:** 
- Good Wi-Fi signal strength is displayed as – **WiFi level:** 
- Fair Wi-Fi signal strength is displayed as – **WiFi level:** 
- Poor Wi-Fi signal strength is displayed as – **WiFi level:** 
- No Wi-Fi signal is displayed as – **WiFi level:** ----

Correcting trouble conditions

The trouble indicator and flashing TRBL message are cleared after you eliminate the cause of the fault. The table below describes the system faults and the corresponding actions to take to resolve the problem. **If you do not know how to correct a fault, report it to your installer and seek their advice.**

Fault	What it means
1-WAY	The device functions but cannot "hear" the panel. The control panel cannot configure or control the device. Battery consumption increases.
AC FAILURE	There is no power supplied to the device.
CLEAN ME	The fire detector must be cleaned
COMM. FAILURE	A message could not be sent to the monitoring station or to a private telephone (or a message was sent but was not acknowledged)
CPU LOW BATTERY	The backup battery within the control panel is weak and must be replaced (see Chapter 8. Maintenance, "Replacing Backup Battery").
CPU TAMPER OPEN	The control panel was physically tampered with or its cover was opened, or it was removed from wall.
GAS TROUBLE	Gas detector failure
GSM NET FAIL	The GSM communicator is not able to connect to the cellular network.
JAMMING	A radio-frequency signal which is blocking all communication frequency channels between the sensors and control panel is detected.
LINE FAILURE	There is a problem with the telephone line
LOW BATTERY	The battery of the indicated device is near the end of its useful life.
MISSING	A device or detector has not reported for some time to the control panel.
NOT NETWORKED	A device was not installed or not installed correctly, or, cannot establish communication with the control panel after installation.
RSSI LOW	The GSM communicator has detected that GSM network signal is weak
SIREN AC FAILURE	There is no power to the siren
TAMPER OPEN	The sensor has an open tamper
TROUBLE	The sensor reports trouble
SOAK TEST FAIL	Detector alarms when in Soak Test mode

Menus and functions

4. Menus and functions

This chapter explains the user programming features of your PowerMaster-360R system and allows you to tailor the PowerMaster-360R system to your specific needs. All menu operations are performed using the Keypad which contains the alarm system's control keys, numerical keypad and display.

The chapter is divided into two sections, as follows:

Part A – Describes how to enter or exit the User Settings menu and how to select the required options.







Part B – Describes how to execute the selected settings.

A.1 Entering the user settings menu & selecting an option



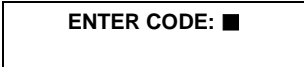

The following procedure describes how to enter and move within the user settings menu. Detailed descriptions of the user settings options are provided at the end of the procedure. To exit the user settings menu – see section A.2.

- i** 1. You can enter the "USER SETTINGS" menu only when the system is disarmed.
2. Carefully read the section titled "Additional information" according to the indicated references ¹ etc. – see table at end of this section.

A. To enter the USER SETTINGS menu

1.  Make sure the system is disarmed and then press the  button repeatedly until the display reads [USER SETTINGS]. ¹
2.  Press 
-  The screen prompts you to enter your user code or present your proximity tag.
3.  Enter your User Code. ²
-  The display reads the first Setting option of the User Settings menu [SET BYPASS]. ³



B. To select an option





































4.  Click the  or  button until the display reads the required option, for example, "TIME & FORMAT".
5.  When the required setting option appears on the display, press the 
- Continue to the selected setting option in B.1 - B.15
- The remainder of the procedures for the selected setting options is provided in sections B.1 to B.15.*



Additional information (section B.1)

- ¹ Display shown in disarm state when all zones are secured (00:00 or other digits show present time).
- ² a. If you have not already changed your personal code number, use the default setting – 1111.
b. Master User has access to all User Settings options. Other users have access only to the Bypass options.
c. If you enter an invalid user code 3 - 5 times, the keypad will be automatically disabled for a pre-defined period of time and the message **WRONG PASSWORD** will be displayed.
- ³ The bypass options will be displayed in the User Settings menu only if enabled by the installer. Otherwise, the first User Settings option displayed will be [USER CODES].

C. User settings options menu

Click  until the display reads the required setting option and then press .

<p>SET ZONE BYPASS</p>  	<p>Use to bypass a faulty (exclude) or unsecured ("disturbed") zone, or to clear a bypassed zone. For further details and programming procedure see section B.1.3.</p>
<p>REVIEW BYPASS</p>  	<p>Use to quickly review the bypass scheme that is to see which zones are bypassed. For further details and reviewing procedure see section B.2.3.</p>
<p>RECALL BYPASS</p>  	<p>Use to recall the last used bypassed scheme for reuse in next arming period. For further details and recalling procedure see section B.3.3.</p>
<p>USER CODES</p>  	<p>Use to program the master user secret access code and the remaining seven other user codes. For further details and programming procedure see section B.4.</p>
<p>DURESS CODE</p>  	<p>Use to program the duress code. For further details and programming procedure see section B.5.</p>
<p>PROXIMITY TAGS</p>  	<p>Use to add new Proximity Tags to or to delete Proximity Tags when lost. For further details and programming procedure see section B.6.</p>
<p>KEYFOBS</p>  	<p>Use to add a new keyfob transmitters or to delete a keyfob transmitter if for example the keyfob is lost. For further details and programming procedure see section B.7.</p>
<p>TIME & FORMAT</p>  	<p>Use to set the time clock to show the correct time and time format. For further details and programming procedure see section B.8.</p>
<p>DATE & FORMAT</p>  	<p>Use to set the calendar date to show the correct date and date format. For further details and programming procedure see section B.9.</p>
<p>AUTO-ARM ENABLE</p>  	<p>Use to enable or disable the option daily arming at predefined times (see Auto-Arm Time setting). For further details and programming procedure see section B.10.</p>
<p>AUTO-ARM TIME</p>  	<p>Use to set the predetermined time for automatic daily arming if enabled (see Auto-Arm Enable setting). For further details and programming procedure see section B.11.</p>
<p>PRIVATE REPORT</p>  	<p>Use to program the four private telephone numbers for reporting alarm and other event messages to private subscribers. For further details and programming procedure see section B.12.</p>
<p>SQUAWK</p>  	<p>Use to enable or disable the squawk sound that is arm / disarm feedback indication. For further details and programming procedure see section B.13.</p>
<p>SCHEDULER</p>  	<p>Use to set the daily / weekly time schedule for start and stop activation of devices connected to the PGM outputs. For further details and programming procedure see section B.14.</p>
<p>VOLUME CONTROL</p>  	<p>Use to adjust the volume level of the various system beeps, and chime signal. For further details and programming procedure see section B.15.</p>
<p>SERIAL NUMBER</p>  	<p>Use to read the system serial number and similar data see section B.16.</p>
<p>PLNK curr.params</p>  	<p>Use to read the current IP address of the PowerLink and similar data see section B.17.</p>
<p><OK> TO EXIT</p>  	<p>Use to exit from the "USER SETTINGS" menu back to Main Menu. For further details see section A.2.</p>

  Returns to first option

Menus and functions

A.2 Returning to the previous step or exiting the USER SETTINGS menu



During the setting process it is frequently necessary to return to the previous setting step or option (i.e. "to go one level up") or to exit the User Settings menu.

A. To move one level up

To move one level up during the setting process, click  once. Each click takes you one level up or to the previous setting step:

B. To exit the USER SETTINGS menu

Any screen

To exit [USER SETTINGS], move up the menu by pressing  repeatedly until the display reads [<OK> TO EXIT], or preferably, press  once which brings you immediately to the exit screen [<OK> TO EXIT].



<OK> TO EXIT

When the display reads [<OK> TO EXIT], press .



















READY 12:00

The system exits the [USER SETTINGS] menu and returns to the normal disarm state while showing the READY display.

A.3 Keys used for navigation and settings

You can use the keypad for various programming functions. The following table provides a description of the keys and their functions:

Key	Definition	Navigation / Setting Function
	Next	Move forward to the next menu options.
	Back	Move backward to the previous menu options.
	OK	Select a menu option or to confirm a setting or action.
	Fire alarm	Configure a fire alarm.
	Volume Up	Increase volume.
	Arm away	Arm building when empty.
	PGM On	Manual activation of a light or other household electrical appliance that is connected to PGM output.
	Volume down	Decrease volume.
	Arm home	Arm building when occupied.
	PGM Off	Manual deactivation of a light or other household electrical appliance that is connected to PGM output.
	Chime	Turn on or off chime.
	OFF	Disarm system.
	Event log	Review the event log.
	PGM Control	Select the active automatic control method: <ul style="list-style-type: none"> ▪ Sensors: The appliance is controlled by sensors (assigned by the installer for this). ▪ Timer: The appliance is controlled by a timer (ON and OFF times are defined by the installer). ▪ Both: The appliance is controlled by sensors as well as by a timer.
	Cancel entry delay	Cancel entry delay when system is armed to home or away.
	Partition	Select a partition.
	Emergency alarm	Configure an emergency alarm.
0 – 9	N/A	Enter numerical data, where applicable.

B.1 Setting the zone bypass option

Bypassing permits arming only part of the system while allowing free movement of people within certain zones

when the system is armed. It is also used to temporarily remove from service faulty zones that require repair work or to deactivate a sensor if, for example, you are decorating a room.

- ◆ Here you can set the Zone Bypass Scheme i.e. to scroll through the list of registered (enrolled) sensors to your PowerMaster-360R system and to Bypass (deactivate) faulty or disturbed sensors (either READY or NOT-READY) or to Clear (reactivate) BYPASSED zones (sensors).

Once you have set a Bypass Scheme you can use the following 3 options:

- > To quickly review the bypassed zones – refer to section B.2.
- > To quickly clear a bypassed zone i.e. to reactivate the bypassed zone – refer to section B.1.
- > To repeat (recall) the last used zone bypassing scheme – refer to section B.3.

- ⓘ
1. Zones will be bypassed throughout one disarm-arm period only. Disarming the system after arming will suspend the entire bypassing scheme but you can recall and reuse it as described in section B.3.
 2. Fire zones cannot be bypassed.
 3. Carefully read the section titled "Additional information" according to the indicated references 1 etc. – see table at end of section B.3.

REMEMBER – ZONE BYPASSING COMPROMISES SECURITY!

A. To bypass a zone

- SET ZONE BYPASS**

Enter the [USER SETTINGS] menu¹, select the [SET ZONE BYPASS]² option and press **OK**.

Z01: READY

The first zone, Z01, is displayed.³

Z01: P1 P2 P3⁴

Living Room
- Z04: NOT READY**

Click the **▶▶** or **◀◀** button until the display reads the zone you wish to bypass (or clear bypass), for example, "Z04" for Zone 04. After several seconds the LED on the respective device starts flashing indicating "it's me".

Z04: P1 P2 P3⁴
- Kitchen**

When the display reads the zone you wish to bypass press **OK**.
- <OK> TO BYPASS**

The display now reads [**<OK> TO BYPASS**].⁵

To bypass the selected zone press **OK**.
- Z04: BYPASSED**

A "Success Tune" 🎵🎶 sounds and the updated zone status is now displayed i.e. [**Z04: BYPASSED**].⁸













B. To Clear a Bypassed Zone

- Z04: BYPASSED**

Repeat steps 1 to 2 above.























Z04: P1 P2 P3⁴

Menus and functions

7.    | OK  **Kitchen** When the zone you wish to clear bypass appears on the display (for example, "Z04"), press  | OK to confirm. You can also identify the device by looking for the "it's me" LED indication on the displayed device.   | OK **<OFF> TO CLEAR** The display now reads **[<OFF> TO CLEAR]**.⁵
8.   | OK    | OK **Z04: READY** To clear the bypassed zone, press the  | OK button.
 A "Success Tune" 🎵 😊 sounds and the updated zone status is now displayed, i.e. **[Z04: READY]** or **[Z04: NOT READY]**.⁹











B.2 Reviewing the zone bypass scheme

◆ Here you can quickly review the bypass scheme that is the zones that are set to be bypassed when the system is next armed.



1.   | OK  **REVIEW BYPASS** Enter the **[USER SETTINGS]** menu and select the **[REVIEW BYPASS]**¹ option and press  | OK.²
2.   | OK  or  **BYPASS LIST** The display reads **[BYPASS LIST]**
 Click the  or  buttons repeatedly to review all bypassed zones in ascending numerical order. When done, click  | OK to exit.⁹
3.   | OK  **Z04: BYPASSED**
    | OK  **Z04: P1 ■ P2 P3**⁴
    | OK  **Kitchen**

B.3 Recalling the zone bypass scheme

◆ Use this option to repeat (recall) the most recent Bypassed Scheme for use during the next arming session.

1.   | OK  **RECALL BYPASS** Enter the **[USER SETTINGS]** menu; select the **[RECALL BYPASS]**¹ option and press  | OK.^{2,6}
2.   | OK  **<OK> TO RECALL** The display now reads **[<OK> TO RECALL]**.⁷
 To recall the last used bypass scheme press  | OK.
3.   | OK  **Bypass RECALLED** A "Success Tune" 🎵 😊 sounds. The display reads **[Bypass RECALLED]** and then returns to "USER SETTINGS" step 1.⁹
 🎵 😊 Return to step 1

Additional information (section B.1 – B.3)

1	For detailed instructions on how to select User Settings –refer to sections A.1 and A.2.
2	This menu is displayed only if "BYPASS" was previously enabled by the installer.
3	<p>a. The STATUS to the right of the zone number indicates whether the zone is READY, NOT-READY or BYPASSED.</p> <p>b. In the example, the display reads [Z01: READY] alternating with [Living Room].</p>
4	This display will appear only if PARTITIONING was previously enabled.
5	<p>a. If the zone you selected is "not bypassed", the display prompts you to press [<OK> TO BYPASS]. However, if the zone you selected is already "bypassed", the display prompts you to press [<OFF> TO CLEAR].</p> <p>b. To cancel and return to the previous step press  or .</p>
6	This menu is not displayed if Partition is enabled.
7	The display now prompts you to press [<OK> TO RECALL] i.e. to repeat the last used bypass scheme. To cancel and return to the User Settings menu, press  .
8	You can now repeat steps 2 - 5 to bypass or clear another zone. To end this session and to select other menu options or to quit programming - follow the instructions in section A.2.
9	You can now select another option in the User Settings menu (see section A.1), or quit programming (see section A.2).

Menus and functions

B.4 Programming user codes

PowerMaster-360R system allows you to authorize up to 48 people to arm and disarm the system by providing each with a unique 4 digit personal security code, and assigning them with different security levels and functionalities. Moreover, you can obtain up to 32 multi-function portable keyfob transmitters that will allow you and the other users to easily arm, disarm and control the system without accessing the panel, including from outside the premises (see section B.7 Add / Delete Keyfob Transmitters). The Duress Code enables you to disarm the system using a special code that sends a silent alarm to the monitoring station.

There are two types of users: Master User and User. The table below summarizes the different operations that can be performed by different users:

User type	Function
Master User	Arm/disarm Zone bypass Authorize other user codes Set user codes Report to private Enroll/delete proximity tag Enroll/delete keyfob Automatic arming Enable squawk Set date and time format Read event log Programming the duress code Read the control panel serial number Read the current IP address of the Power Link
User	Arm/disarm Zone bypass options

The user codes are assigned as follows:

User Code 1 is assigned to the Master User of the system (i.e. the owner). It is the only user code that allows access to the User Settings menu. The default setting of the Master User code is 1111. This code cannot be erased and must be replaced with a secret code as soon as possible.

User Codes 2-4 are assigned to family members, co-workers etc. They enable arming and disarming of the system or of selected partitions as defined by the Master User. They can access the "User Settings" menu only for "zone bypassing" provided this option is enabled in the Installer Mode menu.

User Codes 5-8 are the same as user codes 2-4 but can be assigned to "Latchkey" (child monitor) users. For a detailed explanation of the Latchkey application see Chapter 2 (Arming in the Latchkey Mode) and Appendix C.

Partition Option (For information about Partition option - see Appendix B)











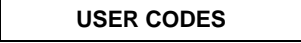

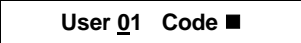

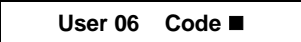

Your alarm system can divide zones into up to 3 parts (groups) through the Installer Mode menu. These parts are designated as partitions P1, P2 & P3. Each partition can be armed and disarmed separately providing protection to selected parts of the premises.

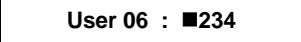
Each user out of the 48 system users can be authorized by the Master User to arm and disarm any combination of partitions including all 3 partitions.

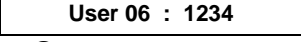

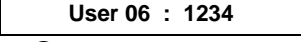









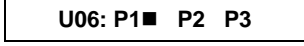



- ◆ Here you can program (or edit) the 8 User Codes and thereby define which of these will be authorized to arm and disarm.

- i**
1. *The default setting 1111 of the Master User Code is the same for all PowerMaster-360R systems and is known to many other people. Therefore, we highly recommend that you immediately replace it with a unique secret code. **Never set any user code the same as any installer code.***
 2. *Code "0000" is not valid! Do not use it.*
 3. *The duress code (2580 by default), which is set in the Installer Mode menu, cannot be selected as a normal user code. Any attempt to program it will be rejected by the system.*
 4. *Carefully read the section titled "Additional information" according to the indicated references ¹ etc. – see table at end of this section.*





A. To program a user code

1.  Enter the [USER SETTINGS] menu, select the [USER CODES] option and press . ¹

 2.  The first user code "User 01 Code" is displayed. ²
 or  At the blinking cursor position, key in the User Code you wish to program, for example, [06] for user code 6, or alternatively click the  or  button until the display reads, [User 06 Code].
 3.  When the user code you wish to program appears on the display, press .

 4.  To program or edit the code, at the blinking cursor position enter the 4 digit code, for example, "1234", using the numerical keypad. ^{3, 4}

 5.  When done, press .

-   Return to step 3
- A "Success Tune"   sounds. The display confirms the saved code. ^{5, 6}

B. To Set Partitions Authorization*

6.  The display will read [SET PARTITIONS]. ⁷

 7.  Use the keypad keys , , ,  and  to change the status of the partitions P1, P2 & P3, respectively. ⁸

 -  When you are satisfied with the setting, for example, User 6 is authorized with Partition 1 and 3 only, press  to confirm.

-   Return to step 3
- A "Success Tune"   sounds. The display confirms the Partition setting. ⁹

Additional information (section B.4)

1	For detailed instructions on how to select the setting options – refer to sections A.1 and A.2.
2	The display shows the 1 st User Code (Master User) in the list of 48 User Codes. If you have not yet changed the default code 1111, we recommend that you change it now.
3	a. The display shows the user code currently programmed in this location (e.g. 5327). b. The cursor blinks on the first digit of the code. c. If the location is free the display will be blank (- - -).
4	You can move the cursor to the next or previous digit by pressing  or  . Pressing  erases the digit of the cursor + all digits right of the cursor.
5	a. The new code is momentarily displayed without the cursor before reverting to step 3. b. If Partition is enabled, continue to step 6.
6	You can now repeat steps 3 - 5 to program or edit another user code. To end this session and to select other menu options or to quit programming – follow the instructions in section A.2.
7	This setting can be performed only after completing steps 1 - 5 of section B.4A.
8	The  symbol now appears next to the newly selected Partitions.
9	You can now repeat steps 3 - 7 to program or edit another user code.







* When PARTITIONING is enabled.

Menus and functions

B.5 Programming the duress code

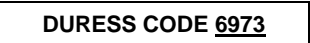
A duress alarm message can be sent to the monitoring station if you are forced to disarm the system. To initiate a duress message, you must disarm the system using the duress code. By default this code is 2580.

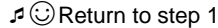
A. To program the duress code

-  Enter the **[USER SETTINGS]** menu, select the **[DURESS CODE]** option and press . ¹
-  At the blinking cursor position, enter the Duress Code, for example, 6973. ^{2,3}
-  When the duress code you wish to program appears on the display, press .
  A "Success Tune"  sounds. The display confirms the saved code. ⁴

Additional information (section B.5)

1	For detailed instructions on how to select the setting options – refer to sections A.1 and A.2.
2	The display shows the default duress code (2580).
3	Do not set the duress code the same as an installer or user code.
4	To end this session and to select other menu options or to quit programming – follow the instructions in section A.2.

B.6 Add and delete proximity tags

A proximity tag may be assigned to each of the user codes 1-48 that can be used instead of the user codes to perform a variety of functions, for example, arming, disarming, reading the event log, etc.









Whenever a user code is required you can simply present a valid proximity tag instead of entering the user code on devices such as KP-141 PG2 or KP-160 PG2. Each tag should be assigned with a serial No. 1-48 that corresponds to the User Code No. 1-48 and correspondingly enrolled in the system.

The partition authorization of the tags has a different authorization than the users.

◆ Here you can add (enroll) new proximity tags or delete tags as required.

 Carefully read the section titled "Additional information" according to the indicated references¹ etc. – see table at end of this section.

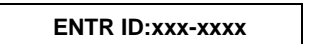
A. To add (enroll) a proximity tag

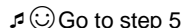
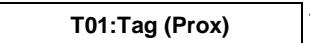
-  Enter the **[USER SETTINGS]** menu; select the **[PROXIMITY TAGS]** option and press . ¹
-  The display will read **[ADD NEW TAG]**. ³
 To begin the process of enrolling a new proximity tag, press .
- 

 Present the proximity tag to the control panel within the timeout period.
-  If enrollment was successfully completed, a "Success Tune"  sounds and the display reads **[DEVICE ENROLLED]** for a short duration and then changes to read the tag's details. ⁴

-  The display shows the allocated tag serial No (user No.), which is always the first free number, for example: **[T01:Tag (Prox)]**.

Menus and functions

or

T05:Tag (Prox)

Return to step 2

To assign the tag to another user, for example, "User No. 5", key in [05] or alternatively click the or button until the display reads [T05:Tag (Prox)] and then press to confirm.

The display reads [DEVICE ENROLLED] a "Success Tune" sounds and the display will then change to [T01:Tag (Prox)].^{5 6}

B. To set partition authorization*

6. **T05:PARTITIONS**

The display will read [T05:PARTITIONS].⁹

7. **T05: P1 ■ P2 ■ P3 ■**

Use the keypad keys **1** **2**, **3** to change the status of the partitions P1, P2 & P3, respectively.¹⁰

T05: P1 ■ P2 P3 ■

When you are satisfied with the setting, for example, User 5 is authorized with Partition 1 and 3 only, press to confirm.

Return to step 2

A "Success Tune" sounds. The display confirms the Partition setting.¹¹

C. To delete a proximity tag

1. **PROXIMITY TAGS**

Enter the [USER SETTINGS] menu, select the [PROXIMITY TAGS] option and press .

2. **ADD NEW TAG**

The display will read [ADD NEW TAG].

Click the button until the display reads [DELETE TAG].

3. **DELETE TAG**

Press .

T01:Tag (Prox)

The display will read [T01:Tag (Prox)].^{2, 7}

4. or

Key in the tag number you wish to delete, for example, [05] or alternatively click the or button until the display reads the tag number, [T05:Tag (prox)].

T05:Tag (Prox)

When the tag you wish to delete appears on the display, press .

5.

<OFF> to delete

The display now reads [<OFF> to delete].⁸

6.

To delete the tag press the button.

DELETE TAG

A "Success Tune" sounds and the display reads [DELETE TAG] and returns to step 3.¹²



Go to step 3

Additional information (section B.6)

1	For detailed instructions on how to select User Settings – refer to sections A.1 and A.2.
2	The display shows the first enrolled Tag (Tag No.1) of the 32 tags.
3	To cancel the enrollment process press the button.
4	If the tag was previously enrolled in the system, the Keypad display reads [ALREADY ENROLLED] and then switches to the name of the tag alternating with its ID number.
5	If Partition is enabled, continue to step 6.

* When PARTITIONING is enabled.

Menus and functions

6	You can now enroll another proximity tag. You can also select another option in the User Settings menu (see section A.1), or quit programming (see section A.2).
7	If no proximity tag is enrolled in the system, the display reads [NO EXISTING DEV.] .
8	To cancel the procedure, press the  button.
9	This setting can be performed only after completing steps 1 - 5 of section B.5A.
10	The  symbol now appears next to the newly selected Partitions.
11	You can now repeat steps 2 - 7 to program or edit another Proximity tag.
12	You can now add or delete another proximity tag. You can also select another option in the User Settings menu (see section A.1 and section A.2), or quit programming (see section A.3).

B.7 Add or delete keyfob transmitters

A portable keyfob transmitter may be assigned to each of the user codes 1-48 for better, quicker and safer arming/disarming and other control functions. Each keyfob should be assigned with a serial No. 1-48 and enrolled into the system correspondingly.

Partition Option (For information about the partition option - see Appendix B)

If the Partition option is enabled in the control panel, up to 32 keyfobs can be authorized by the Master User to arm and disarm any combination, or all 3 partitions, irrespective of the authorization of its corresponding user code.



- ◆ Here you can add (enroll) up to 32 Keyfob transmitters and define which of the 3 partitions each of the keyfob will be authorized to arm and disarm, or delete keyfobs as required.

-  1. Before anything else, gather up all keyfob units you intend to enroll and make sure they all have batteries installed and that they are active (the LED blinks upon pressing any of the buttons).
2. Carefully read the section titled "Additional information" according to the indicated references¹ etc. – see table at end of this section.



A. To add (enroll) a keyfob

- KEYFOBS

Enter the **[USER SETTINGS]** menu; select the **[KEYFOBS]** option and press  **OK**.¹

  **OK**
- ADD NEW KEYFOB

The display will read **[ADD NEW KEYFOB]**.⁴
To enroll a new keyfob press  **OK**.



  **OK**
- ENROLL NOW or



The display offers you two alternative methods to enroll a keyfob:





ENTR ID:xxx-xxxx

A: ENROLL NOW: Press and hold the AUX * button on the selected keyfob until the LED is constantly on.² This procedure completes the enrollment.
- DEVICE ENROLLED



If enrollment was successfully completed, a "Success Tune"   sounds and the display reads **[DEVICE ENROLLED]** for a short duration and then changes to read the keyfob's details. Continue to step 5.



  Go to step 5
- ID No. 300-5786

B: ENROLLMENT BY DEVICE ID: Enter the 7-digit number that appears on the keyfob sticker and then press  **OK** to confirm. To complete the enrollment procedure, see Note 9 in the Additional information table below.

  **OK**

ID ACCEPTED

If a valid ID was entered, a "Success Tune"   sounds and the display reads **[ID ACCEPTED]** for a short duration and then changes to read the keyfob's details. Continue to step 5.

  Go to step 5
- F01:keyfob

The display shows the allocated keyfob serial No (user No.), which is always the first free number, and the keyfob's ID number; for example: **[F01:Keyfob]** alternating with **[ID No. 300-5786]**.



ID No. 300-5786



Menus and functions



F05:keyfob

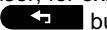

🎵😊 Return to step 2

To assign the keyfob to another user, for example, "User No. 5", key in [05] or alternatively click the  or  button until the display reads [F05:Keyfob] and then press  to confirm.

The display reads [DEVICE ENROLLED] or [ID accepted] if the keyfob was enrolled manually by entering the ID number, a "Success Tune" 🎵😊 sounds and the display will then change to [F01:Keyfob].^{5 6}

B. To set partition authorization*

6. F05:PARTITIONS



The display will read [F05:PARTITIONS]. To enter the menu, press .¹⁰

7. F05: P1 ■ P2 ■ P3 ■

Use the keypad keys , , , ,  to change the status of the partitions P1, P2 & P3, respectively.¹¹

F05: P1 ■ P2 ■ P3 ■

When you are satisfied with the setting, for example, User 5 is authorized with Partition 1 and 3 only, press  to confirm.



🎵😊 Return to step 2

A "Success Tune" 🎵😊 sounds. The display confirms the Partition setting.¹²

C. To delete a keyfob

1. KEYFOBS



Enter the [USER SETTINGS] menu, select the [KEYFOBS] option and press .¹

2. ADD NEW KEYFOB



The display will read [ADD NEW KEYFOB].

Click the  button until the display reads [DELETE KEYFOB].

3. DELETE KEYFOB



Press .

F01:keyfob

The display will read [F01:Keyfob] alternating with the ID number of the keyfob.³

4.  or 

Key in the keyfob number you wish to delete, for example, [06] or alternatively click the  or  button until the display reads the keyfob number, for example, "F06:Keyfob" and "ID No. 300-5799".

F06:keyfob



ID No. 300-6108

When the keyfob you wish to delete appears on the display, press .

5. 

<OFF> to delete

The display now reads [<OFF> TO DELETE].⁸

6. 

🎵😊 Go to step 3



To delete the keyfob press the  button.¹³

DELETE KEYFOB

A "Success Tune" 🎵😊 sounds and the display reads [DELETE KEYFOB] and returns to step 3.¹⁴

* When PARTITIONING is enabled.

Menus and functions









Additional information (section B.7)	
1	For detailed instructions on how to select User Settings – refer to sections A.1 and A.2.
2	The LED will extinguish after several seconds. In case of difficulties in communication with the control panel, the LED may blink for several seconds more while trying to establish communication. During this period of time the keyfob keys are disabled.
3	The display shows the first enrolled Keyfob (Keyfob No.1) of the 32 keyfobs.
4	To cancel enrollment press the  button.
5	If partition is enabled, continue to step 6.
6	You can now enroll another keyfob. You can also select another option in the User Settings menu (see section A.1), or quit programming (see section A.2).
7	If the keyfob was previously enrolled in the system, " ALREADY ENROLLED " appears on the display and then switches to the name of the keyfob alternating with its ID number.
8	Before you delete a keyfob, identify the keyfob either by the keyfob No., for example, F06, or by the ID number of the keyfob that appears on the display, and then make sure that it is the keyfob you wish to delete.
9	<u>Enrollment by Device ID:</u> Step 4b enables you to register the device ID and to complete the programming process without being in possession of the device itself (can also be performed off-site by the installer). Enrollment can then be completed at a later stage by following the same enrollment procedure described in Step 3 without entering the User Settings menu.
10	This setting can be performed only after completing steps 1 - 5 of section B.7A.
11	The  symbol now appears next to the newly selected Partitions.
12	You can now repeat steps 2 - 7 to program or edit another keyfob.
13	To cancel the procedure, press the  button.
14	You can now add or delete another keyfob, select another option in the User Settings menu or quit programming (see sections A.1 A.2).

B.8 Setting the time and format

- ◆ Here you can program or adjust the built-in-clock to show the correct time in the required time format.
- ◆ You can select between a 24 hour and a 12 hour (AM/PM) time format.

 Carefully read the section titled "Additional Information" according to the indicated references¹ etc. – see table at end of this section.

A. To set the time format

-  Enter the **[USER SETTINGS]** menu and select the **[TIME & FORMAT]** option and press .¹
-  The display shows the currently selected time format.²
 Click the  or  button until the display shows the required time format, for example, "**US FORMAT-12H**" and press  to confirm.
- 

B. To set the time ^{5e}

- TIME 12:40P

At the blinking cursor position, enter the correct time, for example, "8:55A", using the numerical keypad. ^{3, 4}
- OK

When you are satisfied with the setting, press **OK** to confirm.

TIME 08:55A

A "Success Tune" 🎵 😊 sounds, the display reads the set time, returns to step 2 and then reads the selected time format. ^{6, 7}

🎵 😊 Return to step 2

Additional information (section B.8)

1	For detailed instructions on how to select User Settings – refer to sections A.1 and A.2..
2	<p>a. The display shows the currently selected format (indicated by a ■ symbol), for example, "24 Hrs".</p> <p>b. You can now select either the 12 Hrs or 24 Hrs time format using the ▶▶ or ◀◀ buttons.</p>
3	<p>The display shows the Time in the selected Time Format, for example, "12:40 PM", with the cursor blinking on the first hour digit "1". The letter that follows the displayed time indicates one of the following: "A" = AM; "P" = PM and "none" for 24 Hrs time format.</p> <p>When the cursor is positioned on the AM/PM digit, you can set to "AM" with the * 🔍 button and the "PM" with the # 🏠 button</p>
4	You can move the cursor to the next or previous digit using the ▶▶ or ◀◀ buttons.
5	This setting can be performed only after completing steps 1 – 3 of section B.8A.
6	The time saved is displayed without the cursor, for example, "08:55 A" followed by the selected time format.
7	You can now select another option in the User Settings menu (see section A.1 and section A.2), or quit programming (see section A.3).

B.9 Setting the date & format

- ◆ Here you can program or adjust the built-in-calendar to show the correct date in the required date format.
- ◆ You can select between a "mm/dd/yyyy" and a "dd/mm/yyyy" date format.

i Carefully read the section titled "Additional information" according to the indicated references¹ etc. – see table at end of this section.

A. To Set the date format

- DATE & FORMAT

Enter the [USER SETTINGS] menu and select the [DATE & FORMAT] option and press **OK**. ¹

OK

DATE DD/MM/YYYY■

The display shows the currently selected date format. ²
- ▶▶ or ◀◀

Click the **▶▶** or **◀◀** button until the display shows the required date format, for example, "MM/DD/YYYY" and press **OK** to confirm.

DATE MM/DD/YYYY■
- OK

B. To set the date ⁷

- DATE 04/20/2014

At the blinking cursor position, enter the correct date, for example, "04/20/2014", using the numerical keypad. ^{3, 4, 5}
- OK

When you are satisfied with the setting, press **OK** to confirm.





DATE 04/20/2014

A "Success Tune" 🎵 😊 sounds, the display shows the set date and returns to step 2 and shows the selected date format. ⁶

🎵 😊 Return to step 2

Menus and functions

Additional information (section B.9)



1	For detailed instructions on how to select User Settings – refer to sections A.1 and A.2.
2	The display shows the currently selected format (indicated by a ■ symbol), for example, "MM/DD/YYYY". You can now select either the "MM/DD/YYYY" or "DD/MM/YYYY" date format by pressing  or  .
3	The display shows the Date and selected Date Format, for example, "30.12.2014", with the cursor blinking on the first digit.
4	You can move the cursor to the next or previous digit using the  or  button.
5	For the year, enter the two last digits only.
6	You can now select another option in the User Settings menu (see section A.1 and section A.2), or quit programming (see section A.3).
7	This setting can be performed only after completing steps 1 – 3 of section B.9A.

B.10 Enabling and disabling auto-arming



The PowerMaster-360R system can be programmed to automatically arm itself on a daily basis at a predetermined time. This feature is useful especially in commercial applications, such as in stores, to ensure that the system is always armed and without having to assign security codes to employees.



- ◆ Here you can enable (activate) and disable (stop) the Auto-Arming. To set the Auto-Arming time – see section B.11.
- ◆ Auto-arming can arm a "NOT READY" system only if forced arming is enabled by the installer while programming your system.





 Carefully read the section titled "Additional information" according to the indicated references¹ etc. – see table at end of this section.



- AUTO-ARM ENABLE**
  | OK

Enter the [USER SETTINGS] menu, select the [AUTO-ARM ENABLE] option and press  | OK. ¹
- disable autoarm ■**

The display shows the currently selected setting. ²
-   or 

Click the  or  button until the display reads the required setting, for example, [enable autoarm] and press  | OK to confirm.
- enable autoarm**



  | OK
  Return to step 1



A "Success Tune"   sounds. The display confirms the saved setting, and then returns to the User Settings menu, step 1. ³

B.11 Setting the auto-arming time



- ◆ Here you can program the exact time of the Auto-Arming.



- AUTO-ARM TIME**

Enter the [USER SETTINGS] menu, select the [AUTO-ARM TIME] option and press  | OK. ¹
-   | OK
arm time 12:00P



The display shows the current setting of the Auto-Arm Time. At the blinking cursor position, enter the correct time, for example, "8:30A", using the numerical keypad. ⁴
-   | OK
TIME 08:30A

When you are satisfied with the setting, press  | OK to confirm.

A "Success Tune"   sounds. The display confirms the saved time and then returns to the User Settings menu, step 1. ^{5,6}

  Return to step 1

Additional information (section B.10 - B.11)

1	For detailed instructions on how to select User Settings – refer to sections A.1 and A.2.
2	The display shows the current setting (indicated by a ■ symbol), for example, [enable auto arm]. You can now select either to enable or disable auto-arming using the  or  button.
3	The ■ symbol now appears next to the newly selected option.
4	The display shows the current setting of the Auto-Arm Time, for example, "12:00 PM", with the cursor blinking on the first hour digit "1". For detailed explanation of how to set the time - refer to Section B.8 B.
5	The saved auto arm time is displayed without the cursor, for example, "08:30 A".
6	You can now select another option in the User Settings menu (see section A.1 and section A.2), or quit programming (see section A.3).

B.12 Programming Email, MMS and SMS reporting

The PowerMaster-360R system can be programmed to send various event notification messages such as alarm, arming or trouble events, to 4 SMS telephone numbers (if a GSM option is installed). In addition, for users who are connected to the PowerManage server, event notification messages can be sent to 4 private emails as well as to 4 private MMS and SMS telephone numbers through the server. These reports can be programmed either instead of or in addition to the reports transmitted to the monitoring company. Further details about the event notification by SMS are provided in Chapter 5. Event reporting and control by SMS.













Here you can program:

- ◆ The specific events you wish the system to report.
- ◆ The 1st, 2nd, 3rd, and 4th MMS, SMS numbers and emails for reporting alarm MMS and other event messages to private subscribers.
- ◆ The SMS permission option allows you to accept SMS commands from four phone numbers configured in the system or from any number.

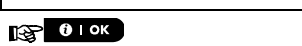
 Carefully read the section titled "Additional information" according to the indicated references¹ etc. – see table at end of this section.

SMS report

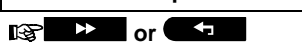
A. To program events to be reported by SMS

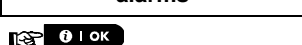
1.  Enter the [USER SETTINGS] menu, select the [PRIVATE REPORT] option and press . ¹
2.  The display will read [SMS REPORT]. To enter this option, press .
3.  When the display reads [REPORTED EVENTS] press . ²
 The display shows the currently selected option.
4.  or  Click the  or  button until the display reads the event group you wish to be reported by SMS, for example, [alarms]. ³

5.  When you are satisfied with the setting, press  to confirm.
 A "Success Tune" 🎵 😊 sounds. The display confirms the set events to be reported, and returns to step 3. ^{4, 10}

🎵 😊 Return to step 3

Menus and functions

B. To program SMS telephone numbers

6. **REPORTED EVENTS** Click the or button until the display reads the SMS phone number you wish to program or edit (out of 4 SMS numbers), for example, "2nd SMS tel#", and press .
 7. **2nd SMS tel#**
 8. **080168593** To program or edit the phone number, at the blinking cursor position enter the SMS phone number, for example, "5080168593", using the numerical keypad.^{5, 6}
 9. **8032759333** When done, press to confirm.
A "Success Tune" 🎵👌 sounds, the display confirms the SMS phone number and returns to step 7.^{7, 10}
- 🎵👌 Return to step 7

C. To program SMS permissions

10. **SMS Permission** Click the or button until the display reads the SMS Permission and press .
11. **From Any** The display shows the currently selected setting
Click the or button until the display reads the option that you require.
When you select the 'From Any' option, SMS commands are accepted from any number.
To enter this option, press .
12. **From Private** When you select this option, the SMS commands only are accepted from the four numbers defined in the private SMS report.
13. When done, press to confirm.

Email by server

A. To program events to be reported by email through the server

1. **PRIVATE REPORT** Enter the [USER SETTINGS] menu, select the [PRIVATE REPORT] option and press .
2. **SMS REPORT** When the display reads [SMS REPORT] press .
3. **EMAIL BY SERVER** To enter this option, press . The display reads [1st E-MAIL].
4. **1st E-MAIL** Click the or button until the display reads the email you wish to program (out of 4 emails), for example, [2nd E-MAIL] and then press .
- 2nd E-MAIL**
- Address** The display reads [Address].
5. Click the button. The display reads [E-MAIL Events].
6. **E-MAIL Events** Press the button.

7. **disable report** ■ The display shows the currently selected option.
7. or Click the or button until the display reads the event group you wish to be reported by email, for example, [**alarm**].⁸
8. **alarm** ■ When you are satisfied with the setting, press to confirm.
- A "Success Tune" 🎵 😊 sounds. The display confirms the set events to be reported, and returns to step 6.*^{4, 10}
- 🎵 😊 Return to step 6

B. To program emails













9. Continue from step 4 in the previous section.
10. **1st E-MAIL** Click the or button until the display reads the email you wish to program or edit, for example, "**2nd E-Mail**", and press .
- or
- 2nd E-MAIL**
-
11. **Address** When the display reads [**Address**], press .
-
12. **■info@visonic.com** To program or edit the email, at the blinking cursor position enter the email, for example, "**info@visonic.com**", using the alphanumeric keypad.^{5, 6}
13. **info@visonic.com** When done, press to confirm.
- A "Success Tune" 🎵 😊 sounds, the display confirms the email and returns to step 11.*^{7, 10}
- 🎵 😊 Return to step 11

SMS and MMS from server





































A. To program events to be reported by SMS through the server

1. **PRIVATE REPORT** Enter the [**USER SETTINGS**] menu, select the [**PRIVATE REPORT**] option and press .
-
2. **SMS REPORT** When the display reads [**SMS REPORT**] press repeatedly until the display reads [**SMS/MMS BY SRVR**].
-
3. **SMS/MMS BY SRVR** To enter this option, press . The display reads [**1st SMS/MMS**].
-
4. **1st SMS/MMS** Click the or button until the display reads the SMS phone number you wish to program (out of 4 SMS numbers), for example, [**2nd SMS/MMS**], and press .
- or
- 2nd SMS/MMS**
-
- Telephone num.** The display reads [**Telephone num.**].
5. Click the button. The display reads [**SMS Events**].
6. **SMS Events** Press the button.
-













Menus and functions

- disable report ■** The display shows the currently selected option.
7.   or   Click the  or  button until the display reads the event group you wish to be reported by SMS, for example, [**alarm**].⁸
- alarm**
8.   When you are satisfied with the setting, press  to confirm.
- alarm ■**
-   Return to step 6
- A "Success Tune"   sounds. The display confirms the set events to be reported, and returns to step 6.*^{4,10}

B. To program events to be reported using MMS through the server

9. **PRIVATE REPORT** Enter the [**USER SETTINGS**] menu, select the [**PRIVATE REPORT**] option and press .¹
-  
10. **SMS REPORT** When the display reads [**SMS REPORT**] press  repeatedly until the display reads [**SMS/MMS BY SRVR**].
-  
11. **SMS/MMS BY SRVR** To enter this option, press . The display reads [**1st SMS/MMS**].
-  
12. **1st SMS/MMS** Click the  or  button until the display reads the MMS phone number you wish to program (out of 4 MMS numbers), for example, [**2nd SMS/MMS**], and press .
-   or  
- 2nd SMS/MMS**
-  
- Telephone num.** The display reads [**Telephone num.**].
13.   Click the  button repeatedly until the display reads [**MMS Events**].
14. **MMS Events** Press the  button.
-  
- disable report ■** The display shows the currently selected option.
15.   or   Click the  or  button until the display reads the event group you wish to be reported by MMS, for example, [**alarm**].⁹
- alarm**
16.   When you are satisfied with the setting, press  to confirm.
- alarm ■**
-   Return to step 14
- A "Success Tune"   sounds. The display confirms the set events to be reported, and returns to step 14.*^{4,10}

C. To program MMS and SMS telephone numbers



17. Continue from step 4 in section A. "To program events to be reported by SMS through the server"
18. **1st SMS/MMS** Click the  or  button until the display reads the SMS/MMS telephone number you wish to program or edit (out of 4 SMS/MMS numbers), for example, "**2nd SMS/MMS**", and press .
-   or  
- 2nd SMS/MMS**
-  
19. **Telephone num.** When the display reads [**Telephone num.**], press .
-  
20. **■895283584** To program or edit the MMS/SMS number, at the blinking cursor position



enter the MMS/SMS telephone number, for example, "895283584", using the alphanumerical keypad.^{5, 6}

When done, press  to confirm.















21.  

895283584

A "Success Tune"   sounds, the display confirms the MMS/SMS telephone number and returns to step 19.¹⁰

  Return to step 19

Menus and functions

Additional information (section B.12)																																			
1	For detailed instructions on how to select User Settings – refer to sections A.1 and A.2.																																		
2	This option allows you to program the events to be reported. To program SMS numbers, click the  or  button until the display reads the required option.																																		
3	<p>The display shows the currently selected option (indicated by a  symbol), for example, "disable report". Using the  or  buttons you can now select the events you wish to be reported to SMS numbers according to the options provided in the table below:</p> <table border="1"> <thead> <tr> <th><u>Event Group Option</u></th> <th><u>Events to be reported</u></th> </tr> </thead> <tbody> <tr> <td>disable report</td> <td>No message are reported</td> </tr> <tr> <td>all</td> <td>All messages</td> </tr> <tr> <td>all (-op/cl)</td> <td>All messages, except arming & disarming</td> </tr> <tr> <td>all (-alerts)</td> <td>All messages, except alerts</td> </tr> <tr> <td>alarms</td> <td>Alarm messages only</td> </tr> <tr> <td>alerts</td> <td>Alert messages only</td> </tr> <tr> <td>op/cl</td> <td>Arming and disarming (open/close) only</td> </tr> </tbody> </table>	<u>Event Group Option</u>	<u>Events to be reported</u>	disable report	No message are reported	all	All messages	all (-op/cl)	All messages, except arming & disarming	all (-alerts)	All messages, except alerts	alarms	Alarm messages only	alerts	Alert messages only	op/cl	Arming and disarming (open/close) only																		
<u>Event Group Option</u>	<u>Events to be reported</u>																																		
disable report	No message are reported																																		
all	All messages																																		
all (-op/cl)	All messages, except arming & disarming																																		
all (-alerts)	All messages, except alerts																																		
alarms	Alarm messages only																																		
alerts	Alert messages only																																		
op/cl	Arming and disarming (open/close) only																																		
4	The  symbol now appears next to the new selected option.																																		
5	<p>a. The display shows the phone number or email currently programmed in this location (for example, 1032759641). The cursor blinks on the first digit of the code.</p> <p>b. If the location is free the display is blank (- - -).</p>																																		
6	You can move the cursor to the next or previous location (digit) using the  or  button.																																		
7	<p>Within the SMS menu, you can now repeat steps 7 - 9 to program or edit another SMS phone number. Within the Email menu, you can now repeat steps 10 - 13 to program or edit another email.</p> <p>To end this session and return to previous menu options, press the  button.</p>																																		
8	<p>The display shows the currently selected option (indicated by a  symbol), for example, "disable report". Using the  or  buttons you can now select the events you wish to be reported to emails or SMS by server according to the options provided in the table below:</p> <table border="1"> <thead> <tr> <th><u>Event Group Option</u></th> <th><u>Events to be reported</u></th> </tr> </thead> <tbody> <tr> <td>disable report</td> <td>No message is reported</td> </tr> <tr> <td>all</td> <td>All messages</td> </tr> <tr> <td>alarm</td> <td>Alarm messages only</td> </tr> <tr> <td>alarm+trbl</td> <td>Alarm and trouble (TRBL) messages</td> </tr> <tr> <td>alarm+o/c</td> <td>Alarm messages, including arming & disarming</td> </tr> <tr> <td>alarm+alrt</td> <td>Alarm and alert messages</td> </tr> <tr> <td>alarm+alrt+trbl</td> <td>Alarm, alert and trouble (TRBL) messages</td> </tr> <tr> <td>alarm+alrt+o/c</td> <td>Alarm and alert messages, including arming & disarming</td> </tr> <tr> <td>alarm+trbl+o/c</td> <td>Alarm and trouble (TRBL) messages, including arming & disarming</td> </tr> <tr> <td>alert</td> <td>Alert messages only</td> </tr> <tr> <td>alert+o/c</td> <td>Alert messages, including arming & disarming</td> </tr> <tr> <td>alert+o/c+trbl</td> <td>Alert and trouble (TRBL) messages, including arming & disarming</td> </tr> <tr> <td>alert+trbl</td> <td>Alert and trouble (TRBL) messages</td> </tr> <tr> <td>trouble</td> <td>Trouble messages only</td> </tr> <tr> <td>trouble+o/c</td> <td>Trouble messages, including arming & disarming</td> </tr> <tr> <td>open/close</td> <td>Arming and disarming (open/close) only</td> </tr> </tbody> </table>	<u>Event Group Option</u>	<u>Events to be reported</u>	disable report	No message is reported	all	All messages	alarm	Alarm messages only	alarm+trbl	Alarm and trouble (TRBL) messages	alarm+o/c	Alarm messages, including arming & disarming	alarm+alrt	Alarm and alert messages	alarm+alrt+trbl	Alarm, alert and trouble (TRBL) messages	alarm+alrt+o/c	Alarm and alert messages, including arming & disarming	alarm+trbl+o/c	Alarm and trouble (TRBL) messages, including arming & disarming	alert	Alert messages only	alert+o/c	Alert messages, including arming & disarming	alert+o/c+trbl	Alert and trouble (TRBL) messages, including arming & disarming	alert+trbl	Alert and trouble (TRBL) messages	trouble	Trouble messages only	trouble+o/c	Trouble messages, including arming & disarming	open/close	Arming and disarming (open/close) only
<u>Event Group Option</u>	<u>Events to be reported</u>																																		
disable report	No message is reported																																		
all	All messages																																		
alarm	Alarm messages only																																		
alarm+trbl	Alarm and trouble (TRBL) messages																																		
alarm+o/c	Alarm messages, including arming & disarming																																		
alarm+alrt	Alarm and alert messages																																		
alarm+alrt+trbl	Alarm, alert and trouble (TRBL) messages																																		
alarm+alrt+o/c	Alarm and alert messages, including arming & disarming																																		
alarm+trbl+o/c	Alarm and trouble (TRBL) messages, including arming & disarming																																		
alert	Alert messages only																																		
alert+o/c	Alert messages, including arming & disarming																																		
alert+o/c+trbl	Alert and trouble (TRBL) messages, including arming & disarming																																		
alert+trbl	Alert and trouble (TRBL) messages																																		
trouble	Trouble messages only																																		
trouble+o/c	Trouble messages, including arming & disarming																																		
open/close	Arming and disarming (open/close) only																																		
9	<p>The display shows the currently selected option (indicated by a  symbol), for example, "disable report". Using the  or  buttons you can now select the events you wish to be reported to MMS telephones numbers according to the options provided in the tables below:</p> <table border="1"> <thead> <tr> <th><u>Event Group Option</u></th> <th><u>Events to be reported</u></th> </tr> </thead> <tbody> <tr> <td>alarm+alrt</td> <td>Alarm and alert messages</td> </tr> <tr> <td>alarm</td> <td>Alarm messages</td> </tr> <tr> <td>alert</td> <td>Alert messages</td> </tr> <tr> <td>disable report</td> <td>No message will be reported</td> </tr> </tbody> </table>	<u>Event Group Option</u>	<u>Events to be reported</u>	alarm+alrt	Alarm and alert messages	alarm	Alarm messages	alert	Alert messages	disable report	No message will be reported																								
<u>Event Group Option</u>	<u>Events to be reported</u>																																		
alarm+alrt	Alarm and alert messages																																		
alarm	Alarm messages																																		
alert	Alert messages																																		
disable report	No message will be reported																																		
10	You can now, select other options, end this session – (see section A.1 and section A.2), or quit programming (see section A.3).																																		

B.13 Enabling and disabling the squawk option

The PowerMaster-360R system (and its wireless sirens) can be set to produce a short "Squawk" of audible feedback to assist you when you use a keyfob to arm (1 beep) and disarm (2 beeps) the PowerMaster-360R system.

◆ Here you can enable or disable the Squawk.

i Carefully read the section titled "Additional information" according to the indicated references¹ etc – see table at end of this section.

- SQUAWK

Enter the [USER SETTINGS] menu, select the [SQUAWK] option and press **i** | OK. ¹
 - Squawk ON ■

The display shows the currently selected setting. ²
 - Click the **▶▶** or **◀◀** button until the display reads the required setting, for example, "Squawk OFF" and press the **i** | OK button to confirm.
 - Squawk OFF ■

A "Success Tune" 🎵 😊 sounds. The display confirms the saved setting, and then returns to the User Settings menu, step 1. ^{3,4}
- 🎵 😊 Return to step 1

Additional information (section B.13)

- | | |
|---|--|
| 1 | For detailed instructions on how to select User Settings – refer to sections A.1 and A.2. |
| 2 | a. The display shows the currently selected setting (indicated by a ■ symbol), for example, [Squawk ON].
b. You can now enable (ON) or disable (OFF) the Squawk option using the ▶▶ or ◀◀ button. |
| 3 | The ■ symbol now appears next to the new selected option. |
| 4 | You can now select another option in the User Settings menu (see section A.1 and section A.2), or quit programming (see section A.3). |

B.14 Programming the Scheduler

The PowerMaster system can be enrolled with wireless input/output (I/O) expanders, which include PGM outputs that can be used to open and close an electrically-controlled gate, or to control a preferred electrical device via keyfobs or according to a programmable weekly time schedule.

Here you can schedule PGM outputs for up to 4 different ON/OFF time activations per any desired day or days of the week. In addition, you can schedule a "Daily" schedule that applies to every day of the week. It is recommended to complete the Scheduler table (placed at the end of this section) before programming the Scheduler.

i Carefully read the section titled "Additional Information" according to the indicated references etc. – see the table at the end of this section.

- SCHEDULER

Enter the [USER SETTINGS] menu, select the [SCHEDULER] option and press **i** | OK. ¹
- PGM No. --

Select the PGM number 01 to 16. Press **i** | OK.

B. To Set the Day ²

- Sunday

The 1st day of the scheduler is displayed.
- Click the **▶▶** or **◀◀** button until the display reads the day you wish to schedule or "Daily", for example, "Tuesday". ²

Menus and functions

Tuesday

4. | OK When the "day" to schedule appears on the display, press | OK.

C. To Select the Activation No. ³

5. or The 1st operation (PGM output activation) of the scheduler is displayed. ³
Click the or button until the display reads the operation you wish to schedule, for example, "operation No 3".

operation No 3

6. | OK When the "operation No." to schedule appears on the display, press | OK.

D. To Set the ON (Start) Time ⁴

7. | OK The "start time" screen is shown on the display. ⁴
To set the start time of the selected operation, press the | OK button.

8. TIME 10:00A The display shows the current setting of the start time. ⁵

TIME 12:30P

Use the numerical keypad to set or change the operation **ON (start)** time, for example, "00:30P". ⁶

9. | OK When you are satisfied with the setting, press | OK to confirm.

Go to step 10

A "Success Tune" sounds. The display confirms the saved start time and returns to the "start time" screen as in step 7.

To set the stop time, continue to step 10.

E. To Set the OFF (Stop) Time

10. | OK Start-HH:MM Click the or button until the display reads "Stop-HH:MM".

or

Stop HH:MM

When the display reads the desired setting, press | OK to confirm.

11. | OK The "stop time" of the selected operation is displayed. ⁵

TIME 01:30P

12. TIME 04:00P Use the numerical keypad to set or change the operation **OFF (stop)** time, for example, "04:00P". ⁶

| OK

When you are satisfied with the setting, press | OK to confirm.

Return to step 5

A "Success Tune" sounds. The display confirms the saved stop time and returns to the "operation No" screen, as in step 5. ⁷

Additional Information (section B.14)

1	For detailed instructions on how to select the Setting Options – refer to sections A.1 and A.2.
2	To activate the selected device on every day of the week at the same time(s), use the "Daily" option. Otherwise, use the or buttons to select the specific day (Sunday, Monday, Tuesday...etc) you wish to activate the PGM output. You can later repeat the process for other days of the week, if desired.
3	The display shows "operation No 1" which is the first of the 4 ON/OFF time activations you can schedule for the day selected in the previous step. You can later repeat the process for the other 3 activations on the selected day, if desired.
4	Here you can select either the "start time" or "stop time" using the or button. Select the time in 10 minute intervals only. To erase a displayed time, press the button. The screen also displays the selected time format.
5	The display shows the current start or stop time setting of the selected activation with the cursor blinking on the first hour digit. If no time is programmed, the time display will be blank (- :- - -).

Menus and functions

6	For detailed explanation of how to set the time - refer to Section B.8.
7	To end this session and return to the previous "operation" menu, press the  button. To select other menu options or to quit programming, follow the instructions in sections A.2 and A.3.

Scheduler Table

Device	Device Description	Day	Operation 1	Operation 2	Operation 3	Operation 4
PGM		Monday	ON: __: __ - OFF: __: __ -	ON: __: __ - OFF: __: __ -	ON: __: __ - OFF: __: __ -	ON: __: __ - OFF: __: __ -
PGM		Tuesday	ON: __: __ - OFF: __: __ -	ON: __: __ - OFF: __: __ -	ON: __: __ - OFF: __: __ -	ON: __: __ - OFF: __: __ -
PGM		Wednesday	ON: __: __ - OFF: __: __ -	ON: __: __ - OFF: __: __ -	ON: __: __ - OFF: __: __ -	ON: __: __ - OFF: __: __ -
PGM		Thursday	ON: __: __ - OFF: __: __ -	ON: __: __ - OFF: __: __ -	ON: __: __ - OFF: __: __ -	ON: __: __ - OFF: __: __ -
PGM		Friday	ON: __: __ - OFF: __: __ -	ON: __: __ - OFF: __: __ -	ON: __: __ - OFF: __: __ -	ON: __: __ - OFF: __: __ -
PGM		Saturday	ON: __: __ - OFF: __: __ -	ON: __: __ - OFF: __: __ -	ON: __: __ - OFF: __: __ -	ON: __: __ - OFF: __: __ -
PGM		Sunday	ON: __: __ - OFF: __: __ -	ON: __: __ - OFF: __: __ -	ON: __: __ - OFF: __: __ -	ON: __: __ - OFF: __: __ -
PGM		Daily	ON: __: __ - OFF: __: __ -	ON: __: __ - OFF: __: __ -	ON: __: __ - OFF: __: __ -	ON: __: __ - OFF: __: __ -

B.15 Volume Control

The system allows you to adjust the volume level of the various system beeps and chime signals.

















Here you can enable / disable the Voice option and change the volume level of the following:

- ◆ Keypad beeps
- ◆ Chime signal
- ◆ Exit / Entry beeps
- ◆ Confirmation beeps
- ◆ Trouble beeps





















Menus and functions









Carefully read the section titled "Additional Information" according to the indicated references etc. – see the table at the end of this section.

-  **VOLUME CONTROL** Enter the [USER SETTINGS] menu, select the [VOLUME CONTROL] option and press . ¹
- KP beeps vol.** The display will read [KP beeps vol.]. To enter this option press .

- MID** ■ The display shows the currently selected option. ²
  or   Click the  or  button until the display reads the desired volume level for the keypad beeps, for example, [MAX]. ³
- MAX**
 When you are satisfied with the setting, press  to confirm. ⁶
MAX ■ A "Success Tune"   sounds. The display confirms the saved setting, then returns to step 2. ^{4, 7, 8}
  Return to step 2

B. To Adjust the Volume Level of the Chime Signal

-   or   Click the  or  button until the display reads [Chime signal vol], and press .
- Chime signal vol**

- MID** ■ The display shows the currently selected option. ²
  or   Click the  or  button until the display reads the desired volume level for the chime signal, for example, [MAX]. ³
- MAX**
 When you are satisfied with the setting, press  to confirm. ⁶
MAX ■ A "Success Tune"   sounds. The display confirms the saved setting, then returns to step 6. ^{4, 8}
  Return to step 6

C. To Adjust the Volume Level of the Exit Entry Beeps







9.   or   Click the  or  button until the display reads **[Exit Entry beeps]**, and press  **I OK**.

10. **Exit/Entry beeps**





MID ■



The display shows the currently selected option. ²



11.   or   Click the  or  button until the display reads the desired volume level for the Exit/Entry beeps, for example, **[MAX]**. ³

MAX







12.   **I OK** When you are satisfied with the setting, press  **I OK** to confirm. ⁶

MAX ■

A "Success Tune"   sounds. The display confirms the saved setting, then returns to step 10. ^{4, 8}

  Return to step 10

D. To Adjust the Volume Level of the Confirmation Beeps







13.   or   Click the  or  button until the display reads **[Confirm. beep v.]**, and press  **I OK**.

14. **Confirm.beeps v.**





MID ■



The display shows the currently selected option. ²



15.   or   Click the  or  button until the display reads the desired volume level for the confirmation beeps, for example, **[MAX]**. ³

MAX







16.   **I OK** When you are satisfied with the setting, press  **I OK** to confirm. ⁶

MAX ■

A "Success Tune"   sounds. The display confirms the saved setting, then returns to step 14. ^{4, 8}

  Return to step 14

E. To Adjust the Volume Level of the Trouble Beeps







17.   or   Click the  or  button until the display reads **[Trouble beeps v.]**, and press  **I OK**.

18. **Trouble beeps v.**





MID ■



The display shows the currently selected option. ²

19.   or   Click the  or  button until the display reads the desired volume level for the trouble beeps, for example, **[MAX]**. ³

MAX

20.   **I OK** When you are satisfied with the setting, press  **I OK** to confirm. ⁶

MAX ■

A "Success Tune"   sounds. The display confirms the saved setting, then returns to step 18. ^{4, 8}

  Return to step 18

Additional Information (section B.15)

¹ For detailed instructions on how to select the Setting Options – refer to sections A.1 and A.2.

Menus and functions







2.	The display shows the currently selected setting (indicated by ■), for example, "MID ■ ".
3	a. Select between MAX , MID , MIN or OFF . b. When you are selecting a level, you will hear a corresponding signal (beeps, chime, prompts, "1, 2, 3") whose volume strength is according to the selected volume level.
4	The ■ symbol now appears next to the newly selected option.
5	You can also adjust the volume level of the beeps by pressing the 1 or 4 buttons, (see B8 – Volume Control).
6	You can now select another option in the User Settings menu (see section A.1 and section A.2), or quit programming (see section A.3).

B.16 Serial number

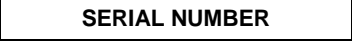
The SERIAL NUMBER menu enables reading the system serial number and similar data for support purposes only.

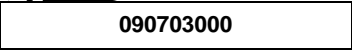
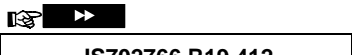
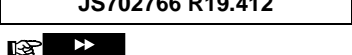
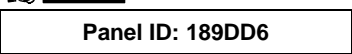
◆ Here you can read the system serial number and other relevant data.

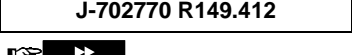
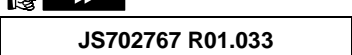
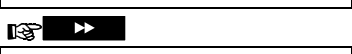
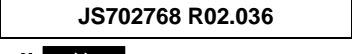
ⓘ Carefully read the section titled "Additional information" according to the indicated references¹ etc. – see table at end of this section.

1.	 SERIAL NUMBER	Enter the [USER SETTINGS] menu, select the [SERIAL NUMBER] option and press  . ¹
2.	 090703000	Displays the control panel serial number.
3.	 JS702766 R19.412	Displays the control panel software version.
4.	 Panel ID: 189DD6	Displays the control panel ID for PowerManage connectivity.
5.	 J-702770 R149.412	Displays the control panel default version.
6.	 JS702767 R01.033	Displays the control panel boot version.
7.	 JS702768 R02.036	Displays the control panel Remote Software Upgrade downloader version.
8.	 PL8.0.92.3 raw	Displays the PowerLink software version.
	 GE910 QUAD V3	Displays the cellular modem type, if installed.
	   Return to step 2	^{2, 3}

Additional information (section B.14)











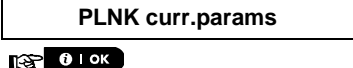

1	For detailed instructions on how to select the Setting Options – refer to sections A.1 and A.2.
2	To end this session and return to previous menu options, press the  button.
3	You can now select another option in the User Settings menu (see section A.1 and section A.2), or quit programming (see section A.3).

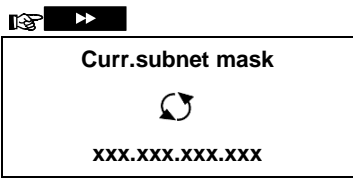
B.17 PowerLink parameters*

The PLNK curr.params menu shows the current IP address, subnet mask, default gateway and current mode of communication. The PowerLink information is for support purposes only.

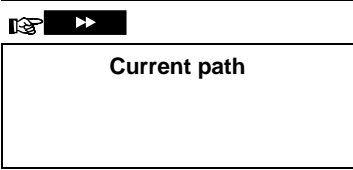
◆ Here you can see the current IP address of the PowerLink and other relevant data.

ⓘ *Carefully read the section titled "Additional information" according to the indicated references¹ etc. – see table at end of this section.*

1.  **PLNK curr.params** Enter the [USER SETTINGS] menu, select the [PLNK curr.params] option and press . ¹
2.  **Curr.IP address** Displays the current PowerLink IP address.

 XXX.XXX.XXX.XXX
3.  **Curr.subnet mask** Displays the current PowerLink subnet mask.

 XXX.XXX.XXX.XXX
4.  **Current Gateway** Displays the current PowerLink default gateway.

 XXX.XXX.XXX.XXX
5.  **Current path** Displays the current PowerLink mode of communication. Press the  button repeatedly until the display shows the required mode and press . Select from one of the following options: **LAN; Cellular; WLAN; None**.

 ☺ Return to step 2

2, 3

Additional information (section B.15)

1	For detailed instructions on how to select the Setting Options – refer to sections A.1 and A.2.
2	To end this session and return to previous menu options, press the  button.
3	You can now select another option in the User Settings menu (see section A.1 and section A.2), or quit programming (see section A.3).

* If the Broadband Module is not registered to the PowerMaster, this menu is not displayed.

5. Event reporting and control by SMS

Event notifications by SMS

The PowerMaster-360R system when equipped with a GSM unit can be programmed to send SMS event notification messages to 4 pre-selected telephone numbers - see Chapter 4, B.12. The messages can be tagged with a "House ID" name, for example, "JOHN'S HOUSE", see Remote Control by SMS section, command no. 8.

Example of the reported SMS messages:

- JOHN'S HOUSE
AWAY
- JOHN'S HOUSE
DISARM
- JOHN'S HOUSE
POWRMASTR-360: LOW BATTERY
GARAGE: LOW BATTERY
- JOHN'S HOUSE
STATUS MESSAGE 01
(Event list is displayed)

Note: Status messages can be sent only to a calling telephone whose identity number is not blocked by the user!

Event reporting & control by telephone and SMS

Remote control by SMS

PowerMaster-360R system with GSM unit can respond to SMS commands from any cellular telephone (a detailed SMS message sending process is described in the cellular telephone user's guide).

The various SMS commands are detailed in the following table.

In this table, "<code>" represents a 4-digit user code and _ represents a blank space (see Note).

SMS Command List

	Command	Individual Partition SMS Format	All Partitions SMS format
1	Arm AWAY	"AWAY_<code>" or "AW_<code>"	"P# AWAY_<code>" or "P# AW_<code>"
2	Arm AWAY instant	"AWAY INST_<code>" or "AWI_<code>"	"P# AWAY INST_<code>" or "P# AWI_<code>"
3	Arm AWAY Latchkey	"LATCHKEY_<code>" or "LK_<code>"	"P# LATCHKEY_<code>" or "P# LK_<code>"
4	Arm AWAY Latchkey instant	"LATCHKEY INST_<code>" or "LKI_<code>"	"P# LATCHKEY INST_<code>" or "P# LKI_<code>"
5	Arm HOME	"HOME_<code>" or "HM_<code>"	"P# HOME_<code>" or "P# HM_<code>"
6	Arm HOME instant	"HOME INST_<code>" or "HMI_<code>"	"P# HOME INST_<code>" or "P# HMI_<code>"
7	Disarm	"DISARM_<code>" or "DA_<code>"	"P# DISARM_<code>" or "P# DA_<code>"
8	Define custom house identity ¹	"HOUSE NAME_<code> <house ID>" or "HN_<code> <house ID>"	"P# HOUSE NAME_<code> <house ID>" or "P# HN_<code> <house ID>"
9	Query system status	"STATUS_<code>" or "ST_<code>"	"P# STATUS_<code>" or "P# ST_<code>"
10	Turn PGM on	"PGM_XX_ON_<code>"	"P# PGM_XX_ON_<code>"
11	Turn PGM off	"PGM_XX_OFF_<code>"	"P# PGM_XX_OFF_<code>"

Note: The PowerMaster-360R may react with a delay to received SMS messages if a GPRS session is in progress at the same time.

¹ House ID includes up to 15 characters, for example, JOHN'S HOUSE

6. Special applications and functions

Looking after people at home

In addition to acting as an alarm system, the PowerMaster-360R can also be used to monitor the movement of people at home when the system is in the disarmed state (or even when armed "HOME" with perimeter protection only). The system can report a **lack of motion** in interior zones if there is no detection of motion within predefined time limits.

To use this feature, you must ask your installer to program a specific time limit beyond which lack of motion will be reported as a "**not active**" alert. For example, let us assume that an elderly person is left unattended in a protected site. This person, will not stay entirely still for hours and so any motion when entering a room is detected by motion detectors.

Important!

To enable motion detectors to function during the disarmed state, all motion detectors must be configured by the installer to detect activity during disarmed state (i.e. "DISARM Activity" recommended setting ""YES + 5m delay"). For further details, refer to the motion detector's Installation Instructions.

If, for example, the "lack of motion" time limit is set by your installer to 6 hours, a virtual 6-hour clock carries out a 6-hour "countdown".

If motion is detected within the 6-hour time frame, the countdown restarts from the beginning (the virtual 6-hour clock will be "reset") and no alert message is sent out.

If no motion is detected within the 6-hour time frame in any interior zone, the control panel sends a "**not-active**" alert message to the monitoring station or to private telephones designated by the installer.

Acknowledging "low battery" condition in Keyfobs

Some regulations and institutions require the user to acknowledge when the keyfob enters a "low battery" condition. In such cases the installer programs the system to operate as follows:

If you try to disarm the system with a keyfob whose battery voltage is low, a protest beep is heard for 15 seconds. During this period you should press again the disarm button of the keyfob or control panel (for the control panel, a user code is required) to disarm the system. If you perform this action during the 15 seconds period, a Low Bat acknowledgement message is stored in the event log.

If the disarm button is not pressed again during the 15 seconds period you will not be able to rearm the system unless you perform either one of the following actions:

- A. Press AWAY twice to arm the system.
- B. Press AWAY and then press the disarm button.

Performing either of these actions stores the acknowledgement message in the event log.

7. Testing the system

Periodic test

The components of your security system are designed to be maintenance-free as much as possible. Nevertheless, it is mandatory to test the system **at least once a week** and after an alarm event to verify that all system sirens, detectors, keyfobs, keypads and other peripherals function properly. Proceed as described in this section and if there is any problem, notify your installer at once.

The test is performed in four parts:

Siren Test: Each siren of the system is automatically activated for 3 seconds (outdoor sirens with low volume). In addition, the system tests the siren of enrolled smoke sensors.

Temp/Light Test: For devices with temperature sensing, the panel displays the temperature of each zone in Celsius or Fahrenheit. For devices that have both temperature and light sensing, the panel displays the temperature and light intensity of each zone.



Other Device Test: Each of the other devices in the system is activated by the user and the display indicates which devices were not yet tested. The "it's me" indication helps to identify the untested devices if necessary. A counter also indicates the number of devices that remain untested.

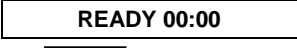

Email Test: Generates an event to be sent to the predefined private email addresses (see Chapter 4, section B.12)

 Carefully read the section titled "Additional information" according to the indicated references¹ etc. – see table at end of this section.



A. To enter the periodic test menu

- 



Make sure the system is disarmed and then press the  button repeatedly until the display reads "PERIODIC TEST" and press .¹

- 

The screen will now prompt you to enter your user code.



- 



Enter your User Code.^{2 3}

  Go to step 4



B. To test the sirens



- 

The display now reads [SIRENS TEST].
- 

To initiate the siren test press . Immediately after pressing , all 5 LEDs on the panel should light (LED test).⁴



The display now reads [SIREN N], where "N" indicates the zone location assigned to the siren that is currently being tested. The first siren enrolled in the panel sounds for 3 seconds after which the PowerMaster-360R system will automatically repeat the procedure for the next siren enrolled in the system until all sirens are tested.⁵ You should listen to the siren's sounds and make sure that all sirens sound. Once all the sirens have been tested, the control panel will then test the sirens of smoke sensors that are enrolled in the alarm system. The display now reads [Zxx: SMOKE SIREN], where "Zxx" indicates the zone number of the smoke sensor, and alternates with [<OK> TO CONTINUE]. During this time, the siren of the tested smoke sensor will sound for up to one minute. Press  to test the siren of the next smoke sensor.
- 







When all the siren tests are complete, the display reads [SIREN TESTS END]. Press the  or the  button to confirm the test and then move to the next step for zone temperature display.

C. To display the temperature and light intensity











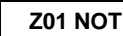
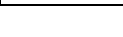

- 

The display now reads [TEMP/LIGHT TEST].

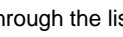





Testing the system

8.  To display the temperature or light intensity of zones on the control panel, press .⁶
- The panel reads the temperature and light intensity of each zone. The display alternates between the temperature, the light intensity, the sensor number and the sensor location.⁷
- Repeatedly click the  button to review the temperature and light intensity of each zone.
9.  or  When the temperature of all zones has been reviewed, the display reads [DEVICE TESTS END]. Press the  or the  button to confirm the test and then move to the next step to test the other devices.

D. To test all other devices

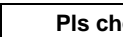
10.  The display now reads [TEST ALL DEVICES].
11.  To enter the devices test procedure, press .
-  The display reads [NOT ACTIVE NNN]. NNN indicates the number of enrolled devices in the panel that have not been tested yet. This number automatically drops one count for every tested device. To initiate devices test, press .
-  The display shows the 1st device in the list of untested devices. The display alternates between the device number, the device type (e.g. magnetic contact, keyfob, keypad, etc.), and the device location.
-  The test is performed by activating each device as explained in point 8 in the Additional information table below.
12.  Click  to scroll through the list of all untested devices.⁹
13.  When all devices have been activated, the display reads [DEVICE TESTS END] followed by [READY 00:00].
-  or  Press the  or the  button to confirm the test and then move to the next step to test the email.

E. To test Emails

14.  The display now reads [E-MAIL TEST].¹⁰
15.  To enter the email test procedure, press .
16.  Check the private email inbox to view the sent email.
-  
-   Return to step 14

Additional information (Periodic Test)

1	Display shown in disarm state when all zones are secured (00:00 or other digits show present time).
2	If you have not already changed your personal code number, use the default setting – 1111.
3	If the INSTALLER CODE is used to enter the Periodic Test instead of the USER CODE, the device's LED

	also provides the link quality indication – see PowerMaster-360R Installer's Guide.
4	To skip the SIRENS TEST and select the other devices TEST, press
5	The Periodic test can be performed on a maximum of two wireless sirens and the sirens of enrolled smoke sensors. Outdoor sirens are activated with low volume.
6	If no temperature sensor is enrolled in the system, the display reads "NO EXISTING DEV." .
7	The displayed temperature can be in Celsius or Fahrenheit according to the programmed settings of the Temperature Sensor.
8	To activate system devices during the "Periodic Test"; make sure the device LED lights when activated: Contact sensor: Open or close the door or window protected by the contact. Motion sensors: Perform a "walk test" of the detector as explained in the detector's datasheet. Smoke sensors: Perform a "Diagnostic test" as explained in the detector's datasheet. Keyfob: Activate any of the keyfob buttons. Keypads: Perform a disarm or arm routine or press any other key that activates the LED. Repeater: Follow the "Diagnostic Tests" described in the repeater's datasheet. Other devices: In general, follow the "Diagnostic Tests" described in the device's datasheet or activate any of its functions.
9	a. Three seconds after the device is displayed, the device LED blinks to assist you to identify ("it's me"). b. To end the session, press the button until the display reads [<OK> TO EXIT] and then press
10	Testing emails must first be configured (see Chapter 4, B.12 "EMAIL BY SERVER").

Periodic test per partition

In addition to the regular Periodic Test, you can also test zones for enrolled sensors (excluding temperature sensors and sirens) that are assigned to a selected partition.

A. To conduct the periodic test per partition ¹

- P1:R P2:N P3:-

Make sure the selected partition is disarmed and the other partitions are not in exit or entry delay and then press the partition (#) button.

MEMORY

TROUBLE
 - SELECT PARTITION

When the display reads [**SELECT PARTITION**], press the partition number of the zones you wish to test, for example, 1 (Partition 1).
 - Partition 1
 - Press the button repeatedly until the display reads [**PERIODIC TEST**] and press .

PERIODIC TEST
 - The screen will now prompt you to enter your Master user code.
 - CODE

Enter your Master user code. ²

P1 SENSORS TEST ³
 - To enter the devices test procedure per partition, press .
 - NOT ACTIVE NNN

↓

The display reads [**NOT ACTIVE NNN**]. NNN indicates the number of enrolled devices in the panel that have not been tested yet. This number automatically drops one count for every tested device.

DEVICE TESTS END
- Test per partition is performed by activating each device as explained in point

Testing the system

4 in the Additional information table below.



After a device has been activated, the control panel reads [Zxx IS ACTIVATED] and the "N" indicator drops one count.

After all devices have been tested, the control panel reads [DEVICE TESTS END].

9.   I OK

🎵 😊 Return to step 3

Press   I OK. ⁵

<i>Additional information (Periodic Test per Partition)</i>	
1	<i>Partitioning must be enabled by your installer.</i>
2	<i>If you have not already changed your personal code number, use the default setting – 1111.</i>
3	<i>To cancel, press the  button; the display reads [<OK> TO END]. Press the  I OK button.</i>
4	<i>To activate system devices during the "Periodic Test Per Partition"; make sure the device LED lights when activated:</i> Contact sensor: <i>Open or close the door or window protected by the contact.</i> Motion sensors: <i>Perform a "walk test" of the detector as explained in the detector's datasheet.</i> Smoke sensors: <i>Perform a "Diagnostic test" as explained in the detector's datasheet.</i>
5	<i>Periodic test per partition will be interrupted (the panel returns to selected partition display) upon occurrence of one of the following: 1) Disarm event by keyfob, keypad or pendant assigned to a selected partition; 2) PANIC, FIRE or EMERGENCY event.</i>

8. Maintenance

Replacing the backup battery

There is generally no need to replace the battery since the battery is rechargeable. If a **CPU LOW BATTERY** trouble message is received when the control panel is connected to AC power and this trouble state continues for more than a few hours, the battery may need to be replaced. An original Visonic battery must be used of which there are a number of types. For assistance in battery replacement, contact Technical Support.

Replacing wireless devices batteries



The **wireless devices** supplied with your system are powered by batteries that last several years, in normal use.

However, if and when a battery becomes weak, the device itself sends a “low battery” message to the control panel, and a low battery trouble message is displayed together with the zone information (see Chapter 3 - Correcting Trouble Situations).

The respective manuals of these sensors or devices should be consulted for proper battery replacement guidelines to be performed by the installer.

Accessing 24-hour zones

To access a sensor defined as a 24-hour zone without causing an alarm:

- Click  - the display shows: **USER SETTINGS**.
- Click  - the display shows: **ENTER CODE ____**.

Key your secret 4-digit **<User Code>** - the buzzer will play the “Success Tune” (- - - ———).

You have 4 minutes during which the 24-hour sensor can be opened and accessed. When the 4 minutes are up, the system will automatically revert to the normal mode.

Cleaning the control panel

The control panel may occasionally get stained if touched with greasy fingers, and may accumulate dust after a long period of use. Clean it only with a soft cloth or sponge moistened lightly with a mixture of water and mild detergent, and then wipe it dry.

The use of abrasives of any kind is strictly forbidden. Also never use solvents such as alcohol, kerosene, acetone or thinner. These will certainly ruin the external finish and damage the transparency of the top window.

Event log

All events are memorized in an event log that contains up to 100 entries. You can access this log, review the events one by one and draw functional conclusions.













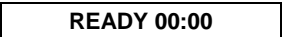

Note: Up to 1000 events are stored in the event log that can be reviewed by the Remote Programmer PC software application or by the remote PowerManage server.

If the event log fills up completely, the oldest event is deleted upon registration of each new event.

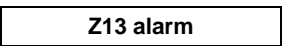
The date and time of occurrence are memorized for each event. When reading the event log, events are shown in chronological order - from the newest to the oldest. The event description is shown first, then the date and time. The two displays are shown alternately several times, until you click  to move on to an older event, or until the “no action” 4-minute timeout restores the system to the normal operating mode.

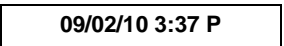







Access to the event log is provided by clicking the  button and then keying your master user code.

To read the event log, proceed as follows:

-   

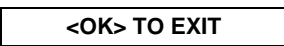
-  **CODE**

When the Keypad display reads [ENTER CODE: _], enter the current master user code.

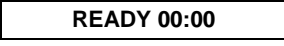
The "Success Tune" will sound and the Keypad display will read [LIST OF EVENTS]. (see *Important Note!*)
-   **OK**

Click the  **OK** button. The latest event will be shown.
The event is displayed in two parts, for example, "Z13 alarm" then "09/02/10 3:37 P".

The two displays will be shown alternately until clicking  **OK** again to move to the next event or until the event log times out (4 minutes).
-   **OK**
Click the  **OK** button as many times as necessary to read all the required data.

Important Note! Entering an incorrect code 3 times in a row, and each next retry, will initiate a 30-second penalty lockout of the keypad.
Attention: The system will not allow you to erase the event log. Only the installer is authorized to view and perform this function.

Exiting the event log

-   or 
Click the  or  button from anywhere within the event log. The Keypad display will read [<OK> TO EXIT].

-   **OK**
Click the  **OK** button.

The system reverts to the normal operating mode.

Appendix A. Controlling device functions

A1. KP-160 PG2

Arming and disarming the system

Step		Operation	User Actions	Keyboard & Panel Response
Optional	1	Select a PARTITION (if Partition is enabled)	Any combination of 	The selected key blinks.
	2	Arm AWAY		The selected key and the "Present Prox Tag" icon () begin to blink and prompt you to present your Tag. The keypad's LED blinks red once to indicate transmission of the arming command to the control panel. The LED and the buzzer then indicate the control panel's response – see KP-160 PG2 User's Guide, "System Status and Indications" section 3.3.
		Arm HOME		
Disarm (OFF)				
Optional	3	Quick arm AWAY (If Quick Arm is enabled)		
		Quick arm HOME (If Quick Arm is enabled)		
Optional	4	INSTANT	(After arming HOME/ AWAY)	
		LATCHKEY	(After arming AWAY)	

Initiating alarms

Alarms	Actions	Response	Notes
Emergency alarm		See section 3.3. in KP-160 PG2 User's Guide	When pressing the Fire or Emergency icons, the KP-160 PG2 starts beeping. After pressing the button for approx. 2 seconds, the KP-160 PG2 sends the command.
Fire alarm			
Panic alarm			When pressing the Fire and Emergency icons together, the KP-160 PG2 starts beeping. After pressing the button for approx. 2 seconds, the KP-160 PG2 sends the Panic command.

Zone status

Alarms	Response	Notes
For NOT READY () / BYPASSED ()		Upon each press of the , the next zone number appears on the zone # display,











Zone status when working with partitions

Alarms	Response	Notes
For NOT READY () / BYPASSED ()		Upon each press of the , the next zone number assigned to the pressed Partition number appears on the zone # display,

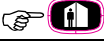

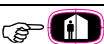
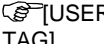
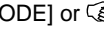
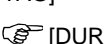
Appendices

A2. KP-140/141 PG2



Arming and disarming the system

Step	Basic Arming	User Actions	Keypad & Panel Response
1	Select a PARTITION (Partition enabled)	 or  or 	The selected button lights.
2	Arm AWAY		The selected button starts blinking and prompts you to enter your "User Code" or present your Tag. See step 3.
	Arm HOME		
	Disarm (OFF)		
	Quick arm AWAY	 (≈ 2 sec.)	The keypad's LED blinks red once to indicate transmission of the arming command to the control panel. The control panel's response is then indicated on the keypad by the LED and the buzzer – see KP-140 PG2 User's Guide, "Panel Response to Keypad Commands" section 3.5
	Quick arm HOME	 (≈ 2 sec.)	
3	Enter USER CODE or present Proximity TAG.	 [USER CODE] or  [present TAG]  [DURESS CODE] (2580 by default)	"Panel Response to Keypad Commands" section 3.5
4	INSTANT	(After arming HOME/ AWAY) 	The keypad's LED blinks red once to indicate transmission of the command to the control panel. The control panel's response is then indicated on the keypad by the LED and the buzzer – see KP-140 PG2 User's Guide, "Panel Response to Keypad Commands" section 3.5.
	LATCHKEY	(After arming AWAY)  	

Initiating Alarms

Alarm	Actions	Response
Emergency alarm	 (≈ 2 sec.)	See KP-140 PG2 User's Guide, "Panel Response to Keypad Commands" section 3.5
Fire alarm	 (≈ 2 sec.)	
Panic alarm	 (≈ 2 sec.)	







Other Functions

Function	User Actions	Response
AUX Function (see Note)		See section 3.5 of KP-140 PG2 User's Guide.
STATUS indication		See section 3.6 of KP-140 PG2 User's Guide.

Note: For the AUX button configuration, see the KP-140 PG2 Installation Instructions.

A3. KF-234 PG2

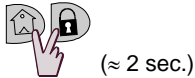
Keyfob functionality

Step	Functions	User Actions	Response
1	Arm AWAY		When executing a command, the keyfob's LED blinks red once to indicate transmission of the command to the control panel. If the operation is successfully completed , the green LED lights momentarily and a "success tune" is heard. If the operation fails or cannot be completed , for example, when the system is "not ready", the red LED lights steadily and a "failure tune" is heard, see KF-234 PG2 User's Guide, "Panel Response to Keyfob Commands" section 3.2.
	Arm HOME		
	Disarm (OFF)		
2	LATCHKEY		
3	Panic alarm		
4	AUX		See section 2.2 of KF-234 PG2 User's Guide.

Appendix B. Partitioning

The control panel includes an optional partition feature. Partitioning is available only if your installer has enabled the feature. Once partitioning is enabled Partitioning menus are added to the system which can be viewed on the touch or virtual keypad display. Partitioning allows you to divide the system into three independently controllable areas with different users assigned to each partition whereby each user can arm the partition to which they are assigned.

Each user code can be assigned to a combination of up to 3 partitions and each partition can be armed or disarmed regardless of the status of the other partitions within the system. For example, you can define the garage as partition 1, the basement as partition 2, and the house as partition 3. Since each partition is independent of other partitions, you can arm or disarm each partition as required without altering the states of the other partitions.

The system also supports a situation where an area is used by two or more partitions. For example, a reception area which is common to two offices, each of which is assigned to a separate partition, will be armed only after both offices (partitions) are armed. In the armed state the reception area will be disarmed after either office (partitions) has been disarmed to allow the user of that office to use the reception area without generating an alarm. Such an area is termed a "common area".

Note: Remote operation is performed per partition, or per user code defined for a particular partition, when partition is enabled.

B1. Selecting a partition

When operating in partition mode the first display will read:

P1: R P2: N P3: R

Press ; the select partition prompt appears on the display:

SELECT PARTITION

Press , and to select the required corresponding partition.

Note: After 5 seconds of no button press there will be a timeout and the display will revert to the All Partition display.

B2. Arming and disarming the system

Before continuing, make sure that Partitioning has been enabled the Installer Mode.

Arming/Disarming All Partitions

To arm/disarm all partitions in READY mode, press the / or button.

Arming/Disarming a Single Partition

To arm/disarm a single partition, press the button on the control panel and then press the Partition number: 1; 2; or 3. Then, press the / or button.

B3. The Show Function

The show function is enabled during single/all partition(s) status and displays information that is relevant to the selected or all partitions.

Show All Partitions

In Ready mode press | OK, the display will show information on all partitions. Press | OK repeatedly to view memory / status content.

Show Single Partition

In Ready mode, press and then press the partition number. The display will show information relevant to the selected partition. Press | OK repeatedly to view memory / status content.

Note: After 5 seconds of no button press there will be a timeout and the display will revert to the all partition display.

B4. Siren

A partition is alarmed when receiving an event from an alarmed device assigned to that partition. Alarmed devices do not affect partitions to which they are not assigned. A siren is common to all partitions; therefore, an alarm from one or more partitions will activate the siren.

Siren Activity

- The siren will be activated when receiving an event from an alarmed device.
- Overlapping siren activations from different partitions will not cause the duration of the siren to be extended.
- When the siren sounds, it will not stop until all alarmed partitions are disarmed. However if the siren is active due to an alarm from a common area zone, and one of the partitions assigned to this area disarms the system, the siren will also stop. In case that the alarm is initiated from a common area but continues with zones that are not assigned to a common area, the siren will not stop until all partitions assigned to the alarmed zones are disarmed.
- In case that there is a fire in partition 1 and a burglary in partition 2, the siren will sound FIRE. When partition 1 is disarmed, the siren will sound BURGLAR for the remainder of the siren timeout period.

B5. Partition status display

Partitions status is indicated in the following manner:

P1:X P2:X P3:X

Each X value indicates a different partition state, as follows:

R	Ready
N	Not ready
A	Away
H	Home
E	Exit delay
D	Entry delay
-	Not used

B6. Common areas

Common areas are areas used as walkthrough zones to areas of 2 or more partitions. There may be more than one common area in an installation depending on the layout of the property. A common area is not the same as a partition; it cannot be armed / disarmed directly. Common areas are created when you assign a zone or zones to 2 or 3 partitions. Table A1 summarizes the behavior of the different zone types in a common area.

Appendices

Table A1 – Common Area Definitions

Common area zone types	Definition
Perimeter	<ul style="list-style-type: none"> • Acts as defined only after the last assigned partition is armed AWAY or HOME. • In case that one of the partitions is disarmed, an alarm initiated from this zone is ignored for all assigned partitions.
Delay zones	<ul style="list-style-type: none"> • Delay zones will not trigger an entry delay unless all assigned partitions are armed. It is, therefore, not recommended to define delay zones as common areas.
Perimeter follower	<ul style="list-style-type: none"> • Act as defined only after the last assigned partition is armed AWAY or HOME. • In case that one of the partitions is disarmed, an alarm initiated from this zone is ignored for all assigned partitions. • In case that one of the common area assigned partitions is in a delay state (and the other partitions are armed), the alarm will behave as a perimeter follower for this partition only. The event will be ignored for other assigned armed partitions.
Interior	<ul style="list-style-type: none"> • Acts as defined only after the last assigned partition is armed AWAY. • In case that one of the partitions is disarmed or armed HOME, an alarm initiated from this zone is ignored for all assigned partitions.
Interior follower	<ul style="list-style-type: none"> • Acts as defined only after the last assigned partition is armed AWAY. • In case that one of the partitions is disarmed or armed HOME, an alarm initiated from this zone is ignored for all assigned partitions. • In case that one of the common area assigned partitions is in a delay state (and the other partitions are armed), the alarm will behave as an interior follower for this partition only. The event will be ignored for other assigned armed partitions.
Home / Delay	<ul style="list-style-type: none"> • Acts as a Perimeter-Follower type when all assigned partitions are armed AWAY. • Acts as a Delay type when at least one of the assigned partitions is armed HOME. • Will be ignored when at least one of the assigned partitions is disarmed.
Emergency; Fire; Flood; Gas; Temperature; 24-hour silent; 24-hour audible; Non-alarm	<ul style="list-style-type: none"> • Always armed.

Appendix C. Glossary

This list of terms is arranged in alphabetical order.

Abort Period: When an alarm is initiated, the internal built-in sounder is activated first for a limited period of time which is the abort period set by the installer. If you cause an alarm accidentally, you can disarm the system within the abort period before the real sirens start and before the alarm is reported to the remote responders.

Alarm: There are 2 kinds of alarm:

Loud alarm - both internal built-in and external sirens blare out constantly and the control panel reports the event by telephone or otherwise.

Silent alarm - the sirens remain silent, but the control panel reports the event by telephone or otherwise.

A state of alarm is caused by:

- Motion detected by a motion detector
- Change of state detected by a magnetic contact detector - a closed window or door is opened
- Detection of smoke by a smoke detector
- Tampering with any one of the detectors
- Pressing the two emergency buttons simultaneously on the panel's keypad.

Arming: Arming the alarm system is an action that prepares it to sound an alarm if a zone is "violated" by motion or by opening a door or window, as the case may be. The control panel may be armed in various modes (see AWAY, HOME, INSTANT and LATCHKEY).

Assigned: Refers to zones.



Associated: Refers to devices.

AWAY: This type of arming is used when the protected site is vacated entirely. All zones, interior and perimeter alike, are protected.

Bypass: Bypassed zones are zones that are not armed when arming the system. Bypassing permits arming only part of the system while allowing free movement of people within certain zones when the system is armed.

Chime Zones: Allow you to keep track of activity in the protected area while the alarm system is in the disarmed state. Whenever a chime zone is "opened", the buzzer beeps twice. The buzzer doesn't beep, however, upon closing the zone (return to normal). Residences can use this feature to announce visitors. Businesses can use it to signal when customers enter the premises or when personnel enter restricted areas.

Note: A 24-hour zone or a fire zone should not be designated as a chime zone, because both zone types actuate an alarm if disturbed while the system is in the disarmed state.

Although one zone or more are designated as chime zones, you can still enable or disable the chime function using the chime ON/OFF button   and  LED

Control Panel: The control panel is a cabinet that incorporates the electronic circuitry and microprocessor that control the alarm system. It collects information from various sensors, processes it and responds in various ways.

Default Settings: Settings that are applicable to a specific device group.

Detector: The device (apparatus) that sends an alarm, that communicates with the control panel (e.g. NEXT PG2 is a motion detector, SMD-426 PG2 is a smoke detector)

Disarming: The opposite of arming - an action that restores the control panel to the normal standby state. In this state, only fire and 24-hour zones will sound an alarm if violated, but an "emergency alarm" may also be initiated.

Disturbed Zone: A zone in a state of alarm (this may be caused by an open window or door or by motion in the field of view of a motion detector). A disturbed zone is considered "not secured".

Appendices

Forced Arming: When any one of the system zones is disturbed (open), the alarm system cannot be armed. One way to solve this problem is to find and eliminate the cause for zone disturbance (closing doors and windows). Another way to deal with this is to impose **forced arming** - automatic de-activation of zones that are still disturbed upon termination of the exit delay. Bypassed zones will not be protected throughout the arming period. Even if restored to normal (closed), bypassed zones will remain unprotected until the system is disarmed.

Permission to "force arm" is given or denied by the installer while programming the system.

HOME: This type of arming is used when people are present within the protected site. A classic example is night-time at home, when the family is about to retire to bed. With HOME arming, perimeter zones are protected but interior zones are not. Consequently, motion within interior zones will be ignored by the control panel, but disturbance of a perimeter zone will cause an alarm.

Instant: You can arm the system AWAY-INSTANT or HOME-INSTANT, thereby canceling the entry delay for all delay zones for the duration of one arming period.

For example, you may arm the control panel in the HOME-INSTANT mode and remain within the protected area. Only perimeter protection is active, and if you do not expect somebody to drop in while the system is armed, alarm upon entry by the main door is an advantage.

To disarm the system without causing an alarm, use your control keypad (which is normally accessible without disturbing a perimeter zone) or use a keyfob transmitter.

It's me: The PowerMaster-360R system includes a powerful device locator that helps you to identify the actual device displayed on the Keypad display, as follows:

While the Keypad displays a zone (device), the LED on the respective device flashes indicating "it's me". The "it's me" indication appears after a certain time delay (max. 16 seconds) and will last for as long as the Keypad displays the device with a timeout of 2 minutes.

Latchkey: The Latchkey mode is a special arming mode in which designated "latchkey users" will trigger a "latchkey message" to be sent to a telephone when they disarm the system.

For example, if parents want to be sure that their child has returned from school and disarmed the system. Latchkey arming is only possible when the system is armed in the AWAY mode.

Magnetic Contact Sensor: A Magnet-controlled switch and a wireless transmitter in a shared housing. The sensor is mounted on doors and windows to detect changes in state (from closed to open and vice versa). Upon sensing that a door or window is open, the sensor transmits an "alarm" signal to the control panel. The control panel, if not armed at that time, will consider the alarm system as "not ready for arming" until the door or window is secured and the panel receives a "restored" signal from the same sensor.

Motion Sensor: A passive Infrared motion sensor. Upon sensing motion, the sensor transmits an alarm signal to the control panel. After transmission, it stands by to sense further motion.

Non-Alarm Zone: Your installer can designate a zone for roles other than alarm. For instance, a motion sensor installed in a dark stairway may be used to switch on lights automatically when someone crosses the dark area. Another example is a miniature wireless transmitter linked to a zone that controls a gate opening mechanism.

Quick Arming: Arming without a user code. The control panel does not request your user code when you press one of the arming buttons. Permission to use this arming method is given or denied by the installer while programming the system.

Remote Responder: A responder can be either a professional service provider to which the home or business owner subscribes (a monitoring station) or a family relation/friend who agrees to look after the protected site during absence of its occupants. The control panel reports events by telephone to both kinds of responders.

Restore: When a detector reverts from the state of alarm to the normal standby state, it is said to have been "restored".

A motion detector restores automatically after detection of movement, and becomes ready to detect again. A magnetic contact detector restores only upon closure of the protected door or window.

Sensor: The sensing element: pyro electric sensor, photo-diode, microphone, smoke optical sensor etc.

Smoke Detector, Wireless: A regular smoke detector and a wireless PowerG transceiver in a shared housing. Upon detection of smoke, the detector transmits its unique identification code accompanied by an alarm signal and various status signals to the control panel. Since the smoke detector is linked to a special fire zone, a fire alarm is initiated.

State: AWAY, HOME, AWAY-INSTANT, HOME-INSTANT, LATCHKEY, FORCED, BYPASS.

Status: AC fail, low battery, trouble, system state etc.

User Codes: The PowerMaster-360R is designed to obey your commands, provided that they are preceded by a valid security access code. Unauthorized people do not know this code, so any attempt on their part to disarm or defeat the system is bound to fail. Some operations, however, can be carried out without a user code as they do not degrade the security level of the alarm system.

Touch or virtual keypad: Contains the user-interface - control keys, numerical keypad and display.

Zone: A zone is an area within the protected site under supervision of a specific detector. During programming, the installer allows the control panel to learn the detector's identity code and links it to the required zone. Since the zone is distinguished by number and name, the control panel can report the zone status to the user and register in its memory all the events reported by the zone detector. Instant and delay zones are "on watch" only when the control panel is armed, and other (24-hour) zones are "on watch" regardless of whether the system is armed or not.

Appendix D. Home fire escape planning

Fire can spread rapidly through your home, leaving you a short time to escape safely. Your ability to get out depends on advance warning from smoke detectors and advance planning - a home fire escape plan that everyone in your family is familiar with and has practiced.

- Pull together everyone in your household and make an evacuation plan.
- Draw a floor plan of your home, showing two ways out of each room, including windows. Don't forget to mark the location of every smoke detector.
Test all smoke detectors (by a qualified testing laboratory) periodically, to ensure their serviceability. Replace batteries as required.
- Make sure that everyone understands the escape plan and recognizes the sound of smoke alarm. Verify that the escape routes are clear and that doors and windows can be opened easily.
- If windows or doors in your home have security bars, make sure that the bars have quick-release mechanisms on the inside, so that they can be opened immediately in an emergency case. Quick release mechanisms won't compromise your security, but they will increase your chances of safely escaping a home fire.
- Practice the escape plan at least twice a year, making sure that everybody is involved - from kids to grandparents. Allow children to master fire escape planning and practice before holding a fire drill at night when they are sleeping. The objective is to practice, not to frighten, so telling children there will be a drill before they go to bed can be as effective as a surprise drill. If children or others do not readily waken to the sound of the smoke alarm, or if there are infants or family members with mobility limitations, make sure that someone is assigned to assist them in fire drill and in the event of an emergency.
- Agree on an outside meeting place where everyone can meet after they've escaped. Remember to get out first, and then call for help. Never go back inside until the fire department gives the OK.
- Have everyone memorize the emergency phone number of the fire department. That way any member of the household can call from a cellular phone or a neighbor's home.
- Be fully prepared for a real fire: when a smoke alarm sounds, get out immediately and once you are out, stay out - leave the firefighting to the professional!
- If you live in an apartment building, make sure that you are familiar with the building evacuation plan. In case of a fire, use the stairs, never the elevator.

Tell guests or visitors to your home about your family's fire escape plan. When visiting other people's home, ask about their escape plan. It is important to be aware of the escape plan when children are permitted to attend "sleepovers" at friends' homes. If they don't have a plan in place, offer to help them make one.

Appendix E. Specifications

E1. Functional

Zones Number	64 wireless zones.
Installer and User Codes	<ul style="list-style-type: none"> • 1 master installer (9999 by default)* • 1 installer (8888 by default)* • 1 master user, no. 1 (1111 by default) • Users no. 2 – 48 • Latchkey users 5 - 8 <p>* Codes must not be identical</p>
Control Facilities	Virtual or Touch keypad, wireless keyfobs and keypads
Arming Modes	AWAY, HOME, AWAY-INSTANT, HOME-INSTANT, FORCED, BYPASS.
Alarm Types	Silent, personal panic/emergency, burglary, gas (CO), and fire.
External Siren (bell) Timeout	Programmable (4 min. by default)
Supervision	Programmable time frame for inactivity alert
Special Functions	<ul style="list-style-type: none"> - Chime zones - Diagnostic test and event log. - Local and Remote Programming over Broadband and GPRS IP connections. - Calling for help by using an emergency transmitter. - Tracking inactivity of people.
Data Retrieval	Alarm memory, trouble, event log
Real Time Clock (RTC)	The control panel keeps and displays time and date. This feature is also used for the log file by providing the date and time of each event
Battery Test	Once every 10 seconds
PowerG Receiver Range	160 ft. (50 m) internal, 6500 ft. (2000 m) external
Connectors	<p>External:</p> <ul style="list-style-type: none"> • DC Power Jack • RJ-45 Ethernet Connector • Micro USB Connector <p>Internal:</p> <ul style="list-style-type: none"> • SIM Card Slot (part of GPRS Module) • Battery Backup Connector

E2. Wireless

RF Network	PowerG – 2-way synchronized Frequency Hopping (TDMA / FHSS)		
Frequency bands (MHz)	433 – 434	868 - 869	912 – 919
Hopping frequencies	8	4	50
Region	Worldwide	Europe	North America and selected countries
Encryption	AES-128		
Maximum Tx Power	10 dBm @ 433 MHz, 14 dBm @868 MHz		
GSM (MHz)	2G Band		3G Band
	850, 900, 1800, 1900		850 ¹ , 900 ² , 1900 ¹ , 2100 ²
Z-Wave (MHz) (optional)	868.4, 908.4, 921.4		
WiFi (optional)	2.4 GHz. Access Point is for IP camera support only.		

¹ ² Bands are determined by the cellular modem type

Appendices

E3. Electrical

External AC/DC adaptor	Input: AC 100-240V, 50/60 Hz, 0.4A Output: 5.1V DC 1.96A
Current Drain	Approximately 200 mA standby, 1500 mA peak at full load.
Low Battery Threshold	3.8 V
Backup Battery Pack	3.7 V, 3000 mAh LIPO, maximum charging voltage is 4.2 V.
Backup Battery Time	12 Hours
Time to Charge	~ 15 Hours (80 %)

E4. Communication

Communication	IP, Ethernet 10/100 (primary mode), and GPRS (secondary mode). The panel can report via Wi-Fi if the connection is configured to a Wi-Fi router.
Monitoring Station Report	2 by PowerManage on IP and/or GPRS
Private Notifications	4 emails, 4 SMS numbers
Local Management Protocol to Windows PC and Android Mobile	USB
Report Destinations	2 Monitoring Stations, 4 private SMS telephones through the server and 4 emails
Reporting Format Options	SIA IP
Supervised Premises Transceiver (SPT) to Control and Indicating Equipment (CIE) interconnection types	Internal UART interfaces
STP Substitution Security	A unique ID is assigned to the control panel during the production process. This ID is used for enrollment to the server. From the server the operator can deliver an encrypted message with the ID to the panel.
Information Security	Keep alive messages are protected with Transport Layer Security (TLS) protocol that prevents the transmitted data from being read and replaces the Power Manage server name and IP address. Event reporting and tunneling is protected by using the Advanced Encryption Standard (AES) 128 encryption.

E5. Physical Properties

Operating Temperature Range	32°F to 122°F (0°C to 50°C)
Storage Temperature Range	5°F to 140°F (-15°C to 60°C)
Humidity	93% relative humidity, @ 30°C (86°F)
Size	158x114.5x36.5 mm (6.22x4.5x1.43")
Weight	225g (8 Oz)
Color	White

E6. Peripherals and Accessory Devices

Modules – factory default (SKU)	Default: <ul style="list-style-type: none"> • Base IP and PowerG • GSM: 2G or 2G/3G Optional: <ul style="list-style-type: none"> • WiFi: 2.4 GHz • Z-Wave: 500 Series
Number of wireless devices	Accommodates more than 120 wireless devices: <ul style="list-style-type: none"> • Up to 64 zones • Up to 15 PIR cameras, 32 keypads, 32 keyfobs, 8 sirens, 4 repeaters
Wireless devices and peripherals	Pendants: PB-101 PG2, PB-102 PG2 Magnetic Contact: MC-302 PG2, MC-302E PG2, MC-302EL PG2, MC-302V PG2

	<p>Motion Detectors: Next PG2; Next K9 PG2, TOWER-20 PG2, TOWER-32AM PG2, TOWER-32AM K9 PG2, TOWER-30AM PG2, TOWER-30AM K9 PG2, CLIP PG2, TOWER CAM PG2</p> <p>PIR Camera Detectors: Next CAM PG2; Next CAM-K9 PG2</p> <p>Note: A maximum of 15 PIR cameras are supported, but the panel will communicate to the Visonic PowerManage server only the first 10 clips received from the cameras.</p> <p>Smoke Detector: SMD-426 PG2, SMD-427 PG2</p> <p>Keyfob: KF-234 PG2, KF-235 PG2</p> <p>Keypad: KP-140 PG2/KP-141 PG2 (with proximity tag), KP-160 PG2</p> <p>Indoor Siren: SR-720 PG2, SR-720B PG2</p> <p>Outdoor Sirens: SR-730 PG2, SR-740 PG2, SR-740 HEX PG2</p> <p>Repeater: RP-600 PG2</p> <p>Gas: GSD-441 PG2, GSD-442 PG2 (CO detector)</p> <p>Glass-break: GB-501 PG2</p> <p>Temperature: TMD-560 PG2</p> <p>Flood: FLD-550 PG2, FLD-551 PG2</p> <p>Shock: SD-304 PG2)</p>
--	---

Appendix F. Compliance with standards

European Standards: EN 300220, EN 300328, EN 301489, EN 50130-4, EN 60950-1, 1, EN 50130-5, EN 50131-3, EN 50131-4, EN 50131-6, EN 50136-1, 2, EN 50131-10

According to the European standard EN50131-1 and EN 50131-3, the PowerMaster 360R security grading is 2 - "low to medium risk" and environmental classification is II – "indoor general". The power supply type is A according to EN 50131-6, built-in siren -type Z warning device according to EN50131-4, and ATS Category is DP4, when IP module primary path and GPRS secondary, according to EN50136-1, EN50136-2 (pass through Operation Mode) and according to EN 50131-10 – Supervised Premises Transceiver (SPT).

Certified by Applicia T&C in accordance with

EN 50131-1, EN 50131-3, EN 50131-6, EN 50131-5-3, EN 50130-5, EN 50131-4,

EN 50130-4, EN 50131-10, EN 50136-1, EN 50136-2

Applicia T&C has certified only the 868 MHz variant of this product.

UK: The PowerMaster-360R is suitable for use in systems installed to conform to PD6662:2010 at Grade 2 and environmental CLASS II. DD243 and BS8243

Hereby, Visonic Ltd. declares that the radio equipment type PM-360R is in compliance with Directive 2014/53/EU. The full text of the EU declaration of conformity is available at the following internet address:
<http://www.visonic.com/download-center>.

U.S. Standards: (FCC) CFR 47 part 15

WARNING! Changes or modifications to this unit not expressly approved by the party responsible for compliance (Visonic Ltd.) could void the user's authority to operate the equipment.

This device complies with Part 15 of the FCC Rules. Operation is subject to the following two conditions:

- (1) This device may not cause harmful interference, and*
- (2) This device must accept any interference received, including interference that may cause undesired operation.*

NOTE: This equipment has been tested and found to comply with the limits for a Class B digital device, pursuant to part 15 of the FCC Rules. These limits are designed to provide reasonable protection against harmful interference in a residential installation. This equipment generates, uses and can radiate radio frequency energy and, if not installed and used in accordance with the instructions, may cause harmful interference to radio communications. However, there is no guarantee that interference will not occur in a particular installation. If this equipment does cause harmful interference to radio or television reception, which can be determined by turning the equipment off and on, the user is encouraged to try to correct the interference by one or more of the following measures:

- Reorient or relocate the receiving antenna.
- Increase the separation between the equipment and receiver.
- Connect the equipment into an outlet on a circuit different from that to which the receiver is connected.
- Consult the dealer or an experienced radio/TV technician for help.

WARNING! To comply with FCC RF exposure compliance requirements, the device should be located at a distance of at least 20 cm from all persons during normal operation. The antennas used for this product must not be co-located or operated in conjunction with any other antenna or transmitter.



W.E.E.E. Product Recycling Declaration

For information regarding the recycling of this product you must contact the company from which you originally purchased it. If you are discarding this product and not returning it for repair then you must ensure that it is returned as identified by your supplier. This product is not to be thrown away with everyday waste.

Directive 2002/96/EC Waste Electrical and Electronic Equipment.



Visonic

EMAIL:

info@visonic.com

INTERNET:

www.visonic.com

©VISONIC LTD. 2017

PowerMaster-360R User's Guide D-307084

Rev 0 (10/17)



D-307084